



## **KS156P-EHL & KS215P-EHL**

15.6" & 21.5" Industrial Touch Panel PC  
User's Manual

## Copyright

This publication contains information that is protected by copyright. No part of it may be reproduced in any form or by any means or used to make any transformation/adaptation without the prior written permission from the copyright holders.

This publication is provided for informational purposes only. The manufacturer makes no representations or warranties with respect to the contents or use of this manual and specifically disclaims any express or implied warranties of merchantability or fitness for any particular purpose. The user will assume the entire risk of the use or the results of the use of this document. Further, the manufacturer reserves the right to revise this publication and make changes to its contents at any time, without obligation to notify any person or entity of such revisions or changes.

Changes after the publication's first release will be based on the product's revision. The website will always provide the most updated information.

© 2023. All Rights Reserved.

## Trademarks

Product names or trademarks appearing in this manual are for identification purpose only and are the properties of the respective owners.

## FCC and DOC Statement on Class A

This equipment has been tested and found to comply with the limits for a Class A digital device, pursuant to Part 15 of the FCC rules. These limits are designed to provide reasonable protection against harmful interference when the equipment is operated in a residential installation. This equipment generates, uses and can radiate radio frequency energy and, if not installed and used in accordance with the instruction manual, may cause harmful interference to radio communications. However, there is no guarantee that interference will not occur in a particular installation. If this equipment does cause harmful interference to radio or television reception, which can be determined by turning the equipment off and on, the user is encouraged to try to correct the interference by one or more of the following measures:

- Reorient or relocate the receiving antenna.
- Increase the separation between the equipment and the receiver.
- Connect the equipment into an outlet on a circuit different from that to which the receiver is connected.
- Consult the dealer or an experienced radio TV technician for help.

## Notice:

1. The changes or modifications not expressly approved by the party responsible for compliance could void the user's authority to operate the equipment.
2. Shielded interface cables must be used in order to comply with the emission limits.

# Table of Contents

- Chapter 1 - Introduction..... 6
  - Overview..... 6
    - I/O Views..... 6
  - Dimensions..... 6
    - KS156P-EHL..... 6
    - KS215P-EHL..... 6
  - Key Features..... 7
  - Specifications..... 8
- Chapter 2 - Hardware Installations..... 10
  - Removing the Chassis Cover..... 10
  - Installing a SSD Tray..... 11
  - Installing a M.2 Card..... 12
  - Installing an Antenna..... 13
  - Mounting Options..... 14
    - Wall Mount..... 14
    - Panel Mount - KS156P-EHL..... 15
    - Panel Mount - KS215P-EHL..... 16
- Chapter 3 - System Settings..... 17
  - System Layout..... 17
    - Top View..... 17
    - Bottom View..... 17
  - Jumper Settings..... 18
    - CLEAR CMOS Data..... 18
    - Panel Backlight Selection..... 18
    - Panel Inverter Power Selection..... 19
    - Panel VDD Power Jumper..... 19
    - COM1 Power Selection..... 20
    - COM2 Power Selection..... 20
  - Pin Assignment..... 21
    - USB Ports..... 21
    - Front Audio..... 21
    - Digital I/O Connector..... 22
    - Cooling Fan Connectors..... 22
    - COM (Serial) ports..... 23
    - InnoAGE HDR1..... 24
    - COM (Serial) ports..... 24
    - InnoAGE HDR1..... 25
    - Front Panel..... 25
    - Battery Header..... 26
    - S/PDIF Connector..... 26
    - DIO Power..... 27
    - LVDS Backlight..... 27
    - SATA Power..... 28
    - Heater..... 28
- Chapter 4 - BIOS Settings..... 29
  - Overview..... 29
  - Main..... 30
  - Advanced..... 30
    - RC ACPI Settings..... 31
    - CPU Configuration..... 31
    - Power & Performance..... 32
    - PCH-FW Configuration..... 32

- Trusted Computing..... 33
- NCT6126D Super IO Configuration..... 33
- NCT6126D Super IO Configuration ▶ **Serial Port 1, 2 Configuration..... 34**
- NCT6126D Super IO Configuration ▶ **Serial Port 3, 4 Configuration..... 34**
- NCT6126D Super IO Configuration ▶ **Serial Port 5, 6 Configuration..... 35**
- NCT6126D HW Monitor..... 35
- Smart Fan Function..... 36
- Serial Port Console Redirection..... 36
- Serial Port Console Redirection ▶ **Console Redirection Settings..... 37**
- USB Configuration..... 37
- Network Stack Configuration..... 38
- USB Power Control..... 38
- Chipset..... 39
  - System Agent (SA) Configuration..... 39
  - PCH-IO Configuration..... 40
  - PCH-IO Configuration ▶ **PCI Express Configuration..... 40**
  - PCH-IO Configuration ▶ **SATA Configuration..... 41**
  - PCH-IO Configuration ▶ **Audio Configuration..... 41**
- Security..... 42
  - Secure Boot..... 42
- Boot..... 43
- Save & Exit..... 43
- Updating the BIOS..... 44
- Notice: BIOS SPI ROM..... 44

## About this Manual

This manual can be retrieved from the website.

The manual is subject to change and update without notice, and may be based on editions that do not resemble your actual products. Please visit our website or contact our sales representatives for the latest editions.

## Warranty

1. Warranty does not cover damages or failures that arises from misuse of the product, inability to use the product, unauthorized replacement or alteration of components and product specifications.
2. The warranty is void if the product has been subjected to physical abuse, improper installation, modification, accidents or unauthorized repair of the product.
3. Unless otherwise instructed in this user's manual, the user may not, under any circumstances, attempt to perform service, adjustments or repairs on the product, whether in or out of warranty. It must be returned to the purchase point, factory or authorized service agency for all such work.
4. We will not be liable for any indirect, special, incidental or consequential damages to the product that has been modified or altered.

## About this Package

The package contains the following items. If any of these items are missing or damaged, please contact your dealer or sales representative for assistance.

- 1 Touch Panel PC
- 1 Quick Installation Guide

Note: The items are subject to change in the developing stage.

The product and accessories in the package may not come similar to the information listed above. This may differ in accordance with the sales region or models in which it was sold. For more information about the standard package in your region, please contact your dealer or sales representative.

## Static Electricity Precautions

It is quite easy to inadvertently damage your PC, system board, components or devices even before installing them in your system unit. Static electrical discharge can damage computer components without causing any signs of physical damage. You must take extra care in handling them to ensure against electrostatic build-up.

1. To prevent electrostatic build-up, leave the system board in its anti-static bag until you are ready to install it.
2. Wear an antistatic wrist strap.
3. Do all preparation work on a static-free surface.
4. Hold the device only by its edges. Be careful not to touch any of the components, contacts or connections.
5. Avoid touching the pins or contacts on all modules and connectors. Hold modules or connectors by their ends.



### Important:

Electrostatic discharge (ESD) can damage your processor, disk drive and other components. Perform the upgrade instruction procedures described at an ESD workstation only. If such a station is not available, you can provide some ESD protection by wearing an antistatic wrist strap and attaching it to a metal part of the system chassis. If a wrist strap is unavailable, establish and maintain contact with the system chassis throughout any procedures requiring ESD protection.

## Safety Precautions

- Use the correct DC / AC input voltage range.
- Unplug the power cord before removing the system chassis cover for installation or servicing. After installation or servicing, cover the system chassis before plugging in the power cord.
- There is danger of explosion if battery incorrectly replaced.
- Replace only with the same or equivalent specifications of batteries recommend by the manufacturer.
- Dispose of used batteries according to local ordinance.
- Keep this system away from humid environments.
- Make sure the system is placed or mounted correctly and stably to prevent the chance of dropping or falling may cause damage.
- The openings on the system shall not be blocked and shall be kept in distance from

other objects to make sure of proper air ventilation to protect the system from over-heating.

- Dress the cables, especially the power cord, so they will not be stepped on, in contact with high temperature surfaces, or cause any tripping hazards.
- Do not place anything on top of the power cord. Use a power cord that has been approved for use with the system and is compliant with the voltage and current ranges required by the system's electrical specifications.
- If the system is to be unused or stored for a long time, disconnect it from the power source to avoid damage by transient overvoltage.
- If one of the following occurs, consult a service personnel:
  - The power cord or plug is damaged.
  - Liquid has penetrated the system.
  - The system has been exposed to moisture.
  - The system is not working properly.
  - The system is physically damaged.
- The unit uses a three-wire ground cable which is equipped with a third pin to ground the unit and prevent electric shock. Do not defeat the purpose of this pin. If your outlet does not support this kind of plug, contact your electrician to replace the outlet.
- Disconnect the system from the electricity outlet before cleaning. Use a damp cloth for cleaning the surface. Do not use liquid or spray detergents for cleaning.
- Before connecting, make sure that the power supply voltage is correct. The device is connected to a power outlet which should be grounded connection.



The system may burn fingers while running.

Wait for 30 minutes to handle electronic parts after power off.

## Chapter 1 - Introduction

### ► Overview

#### I/O Views

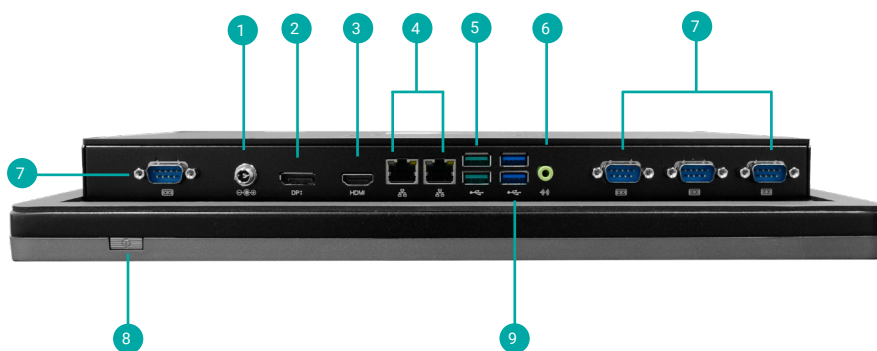

- |            |                 |
|------------|-----------------|
| 1 DC-In    | 5 USB 3.2 Gen1  |
| 2 DP++     | 6 Line-Out      |
| 3 HDMI     | 7 COM Ports 1~4 |
| 4 2.5G LAN | 8 Power Button  |
|            | 9 USB 3.2 Gen2  |

### ► Dimensions

#### KS156P-EHL

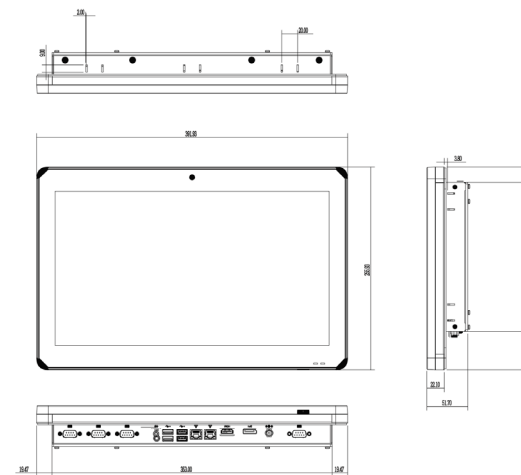

#### KS215P-EHL

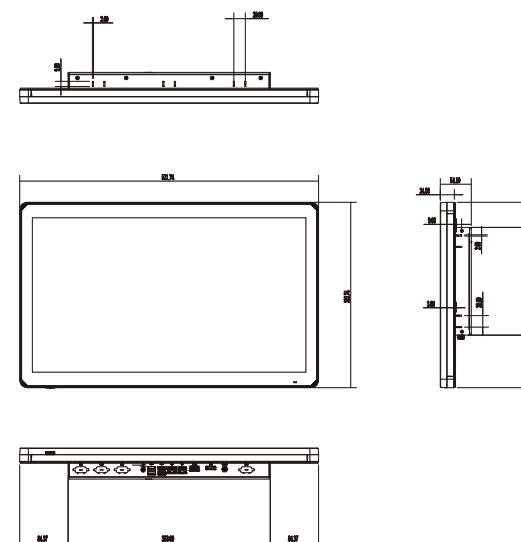

► **Key Features**

---

**CPU Performance:**

Intel® Atom® x6425E Processor, Quad Core  
Intel® Atom® x6413E Processor, Quad Core

**Touch Type:**

Projected Capacitive Touch

**Dual Display:**

HDMI & DP++

**Multiple Expansions:**

M.2 2242/2280/3052 B Key  
M.2 2230 E Key

**Wide Voltage:**

Support 9 ~ 36V

► Specifications

<b>DISPLAY AND TOUCH SCREEN</b>	Display	KS156P-EHL: 15.6" TFT LCD Panel KS215P-EHL: 21.5" TFT LCD Panel
	Contrast	16 : 9
	Max. Resolution	1920 x 1080
	Touch Type	Projected Capacitive
	Brightness	KS156P-EHL: 400 (cd/m2) KS215P-EHL: 300 (cd/m2)
	Backlight Lifetime	50,000 (hours)
<b>SYSTEM</b>	Processor	Intel® Atom® x6425E Processor, Quad Core, 1.5M Cache, 2.0GHz (3.0GHz), 12W Intel® Atom® x6413E Processor, Quad Core, 1.5M Cache, 1.5GHz (3.0GHz), 9W
	Memory	Two 260-pin SODIMM up to 32GB Dual channel DDR4 up to 3200MHz
	BIOS	AMI SPI 256Mbit (supports UEFI boot only)
<b>GRAPHICS</b>	Controller	Intel® UHD Graphics
	Feature	OpenGL 4.5, DirectX 12, Open CL 1.2, Vulkan 1.1 HW Decode: AVC/H.264, MPEG2, VC1/WMV9, JPEG/MJPEG, HEVC/H.265, VP8, VP9 HW Encode: AVC/H.264, JPEG/MJPEG, HEVC/H.265, VP9
	Display	1 x DP++ DP++: resolution up to 4096x2160 @ 60Hz 1 x HDMI 2.0 HDMI: resolution up to 4096x2160 @ 24Hz
	Dual Displays	DP++ & HDMI
<b>STORAGE</b>	External	1 x 2.5" SATA 3.0 Drive Bay
<b>EXPANSION</b>	Interface	1 x M.2 2242/2280/3052 B Key (PCIe x1/SATA/USB2.0) 1 x M.2 2230 E Key (PCIe x1/USB2.0) 1 x Nano SIM Socket (connected to M.2 B key)
<b>I/O</b>	Ethernet	2 x GbE (RJ-45)
	Serial	2 x RS-232/422/485 2 x RS-232
	USB	2 x USB 3.2 Gen2 2 x USB 3.2 Gen1
	Display	1 x DP++ 1 x HDMI
	Audio	1 x Line-Out
	Button	1 x Power Button



<b>POWER</b>	Type	DC 9-36V
	Connector	DC Jack
<b>MECHANISM</b>	Construction	Plastic + Sheet Metal
	Mounting	VESA Mount 100 x 100
	IP Rating	IP65 Front Panel Protection Without Power Button
	Dimensions(W x H x D)	KS156P-EHL: 392 x 256 x 51.7 mm KS215P-EHL: 521.8 X 323.8 X 54.1 mm
	Weight	KS156P-EHL: 4.1 Kg KS215P-EHL: 7.0 Kg
<b>ENVIRONMENT</b>	Operating Temperature	0°C ~ 50°C
	Storage Temperature	-30°C ~ 80°C
	Relative Humidity	10 to 95% @ 40°C, non-condensing
<b>STANDARDS AND CERTIFICATIONS</b>	Shock	OP: Half-sine, 3G @ 11ms Non-OP: Half-sine, 5G @ 11ms
	Vibration	OP: Random, 1Grms @ 5~500Hz, 30min Non-OP: Sweep sine, 3Grms @ 10~500Hz, 30min
	Certifications	CE, FCC, Class A, UKCA

## Chapter 2 - Hardware Installations

### ► Removing the Chassis Cover

Please observe the following guidelines and follow the instructions to open the system.

1. Make sure the system and all other peripheral devices connected to it have been powered off.
2. Disconnect all power cords and cables.

#### Step 1:

The 8 screws of the system are used to secure the cover to the chassis. Remove the screws and put them in a safe place for later use.

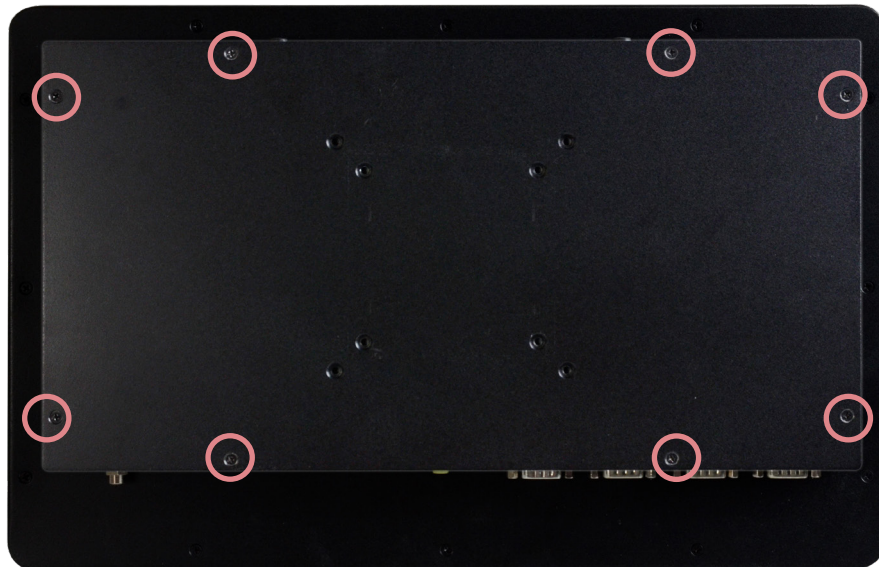

#### Step 2:

Lift the cover to open the system.

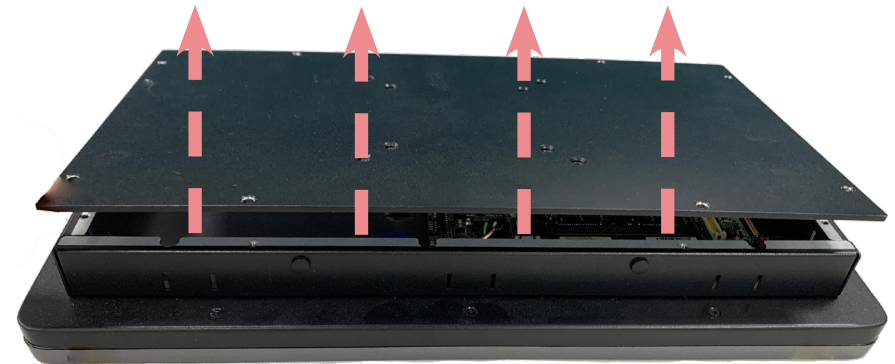

### ► Installing a SSD Tray

The SSD Tray can be mounted with a 2.5" SATA SSD and secured onto the system board for storage. Please follow the steps below for the assembly.

1. Place the SATA SSD in between the SSD brackets while making sure the SATA connector can be access.



2. Screw in the four black screws from each bracket to secure a SSD in place.

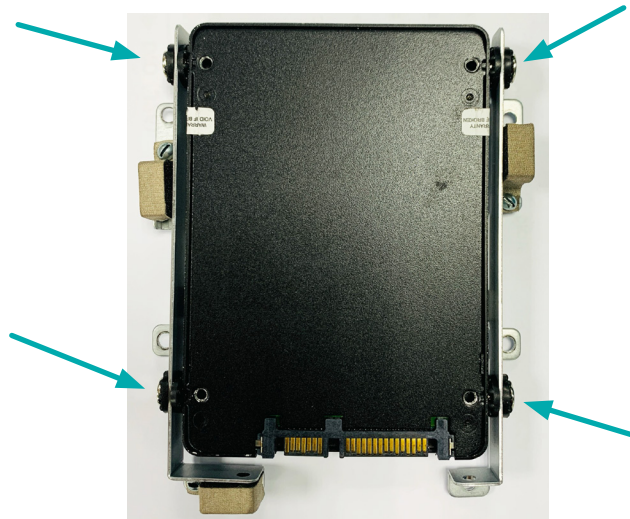

3. Screw in the four screws provided in the package to secure the SSD tray in place.

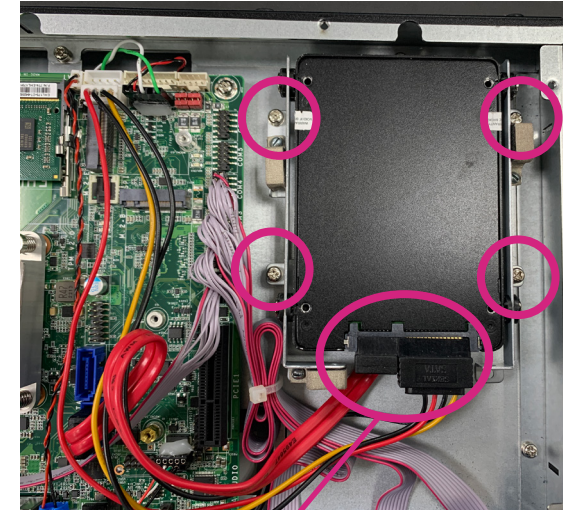
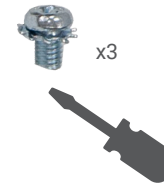

4. Connect the SATA cable and the SATA power cable to SSD and the board connectors.



**Note:**  
After the SATA SSD is correctly mounted, please attach the bottom cover back on as previously instructed

► **Installing a M.2 Card**

Before installing the M.2 module into the M.2 socket, please make sure that the following safety cautions are well-attended.

1. Make sure the PC and all other peripheral devices connected to it has been powered down.
2. Disconnect all power cords and cables.
3. Locate the M.2 socket on the system board
4. Make sure the notch on card is aligned to the key on the socket.
5. Make sure the standoff screw is removed from the standoff.

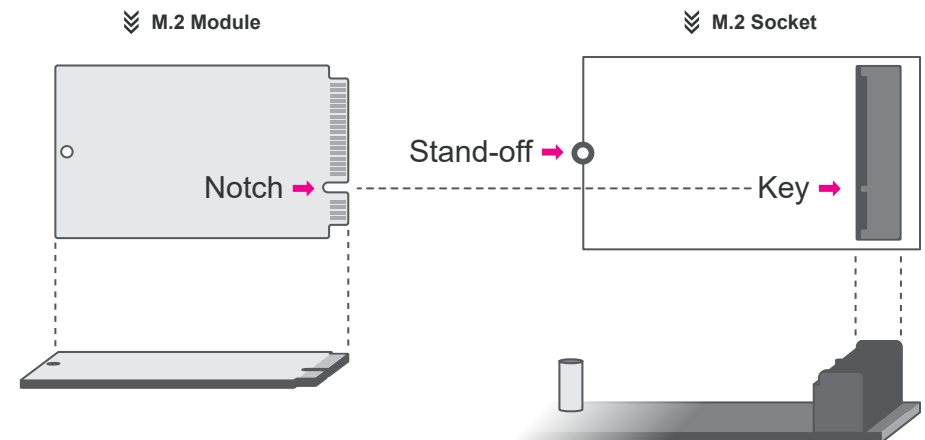
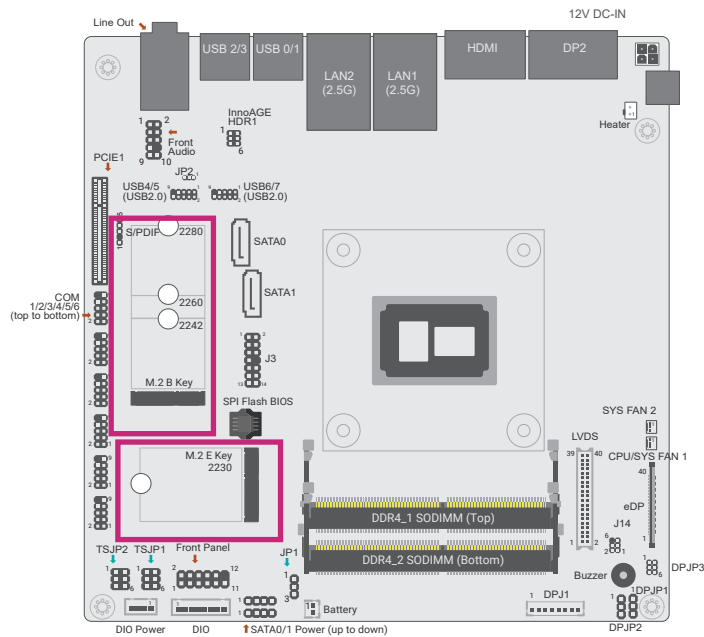

Please follow the steps below to install the card into the socket.

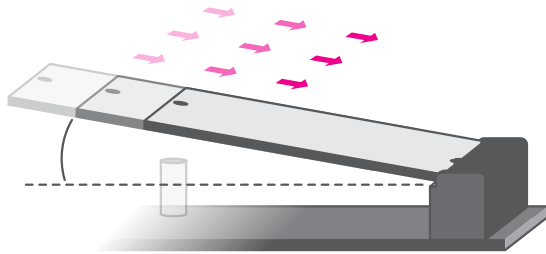

**Step 1:**  
 Insert the card into the socket at an angle while making sure the notch and key are perfectly aligned.

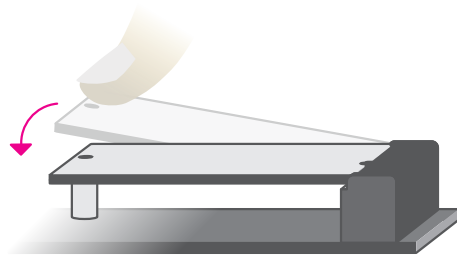

**Step 2:**  
 Press the end of the card far from the socket down until against the stand-off.

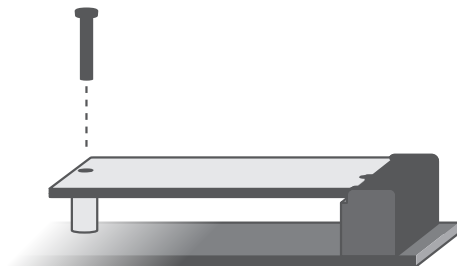

**Step 3:**  
 Screw tight the card onto the stand-off with a screw driver and a stand-off screw until the gap between the card and the stand-off closes up. The card should be lying parallel to the board when it's correctly mounted.

► **Installing an Antenna**

Before installing the antenna, please make sure that the following safety cautions are well-attended.

1. Make sure the PC and all other peripheral devices connected to it has been powered down.
2. Disconnect all power cords and cables.

**Step 1:**  
 There are antenna holes reserved on the rear side of the system and covered by rubber plugs. Please remove the plug prior to installing an antenna.



**Step 2:**  
 Connect the internal cable to the board's antenna connector, screw the antenna connector through the antenna hole with washers and nuts, and screw on the antenna as illustrated below.

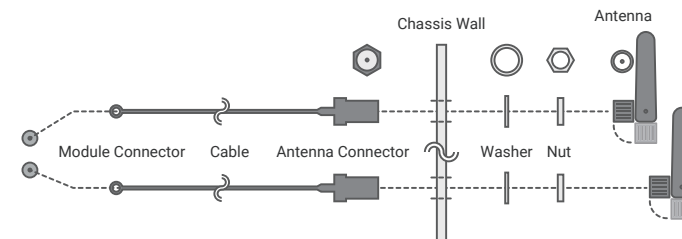

## ► Mounting Options

### Wall Mount

#### Step 1:

Select a place on the wall where you will mount the Panel PC.

#### Step 2:

Use the provided mounting screws to attach **wall mount bracket 1** onto the wall.

#### Step 3:

Attach the other bracket (**wall mount bracket 2**) to the rear of the Panel PC.

#### Step 4:

Slide the Panel PC to **wall mount bracket 1** and attach the two brackets together with the hooks. Then tighten the screw to secure the assembly in place.

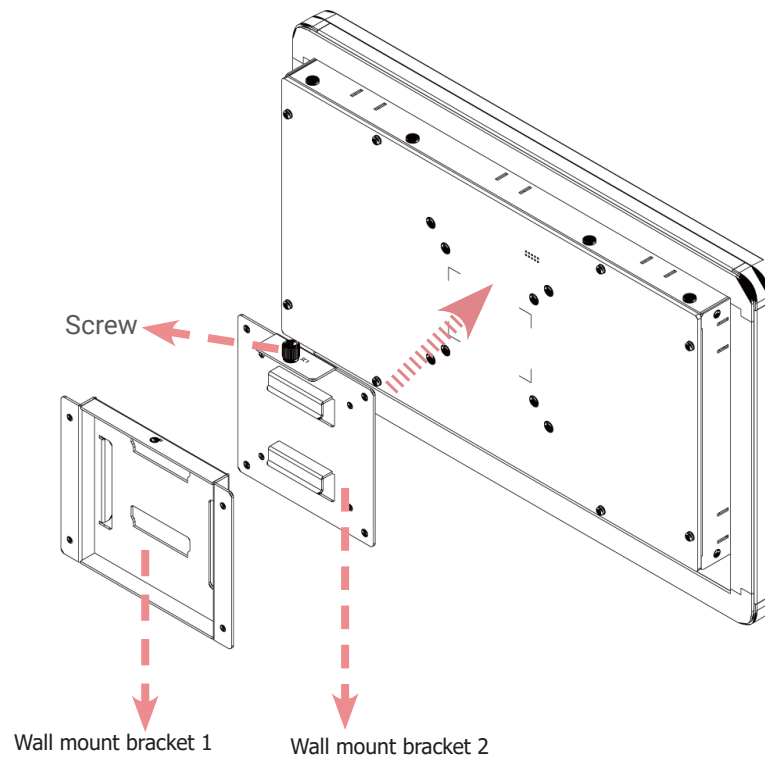

## Panel Mount - KS156P-EHL

### Step 1:

Select a place on the panel (or wall) where you will mount the Panel PC.

### Step 2:

Cut out a shape on the panel that corresponds to the Panel PC's rear dimensions (359mm x 194mm) and ensure that the Panel PC can be fitted into the panel properly.

The flat panel thickness is less than 3mm. Be sure to route or trim down the thick wall to 3 mm or slightly less for the clamps to recess and be compatible with your wall or enclosure.

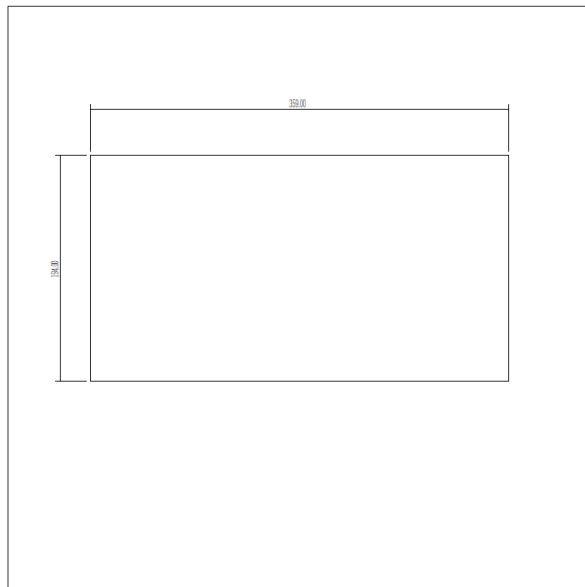

### Step 3:

Insert the Panel PC from the outside surface of the panel into the mounting hole until it is properly fitted against the panel.

### Step 4:

Position the mounting clamps along the rear edges of the Panel PC and insert them into the slits around the Panel PC.

### Step 5:

The first and second clamps must be positioned and secured diagonally prior to mounting the rest of the clamps. Tighten the clamp's screw using an electric screwdriver by pressing the white plastic cap onto the back of the panel. The illustration below shows that all clamps are properly mounted.

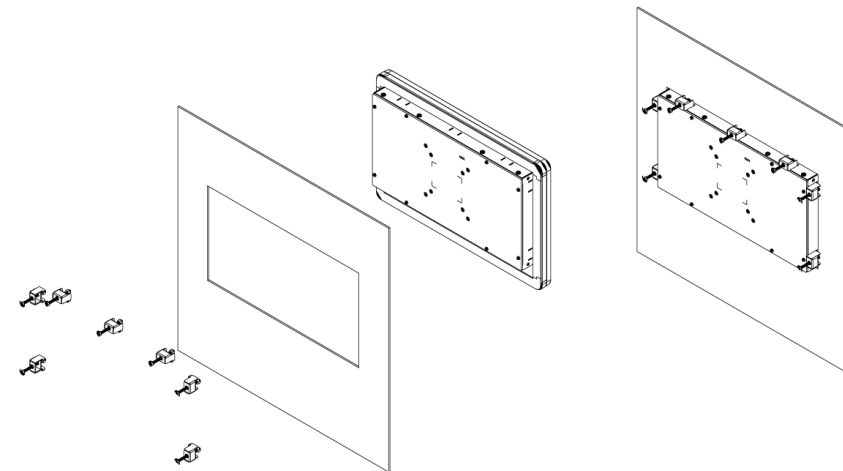

### Panel Mount - KS215P-EHL

#### Step 1:

Select a place on the panel (or wall) where you will mount the Panel PC.

#### Step 2:

Cut out a shape on the panel that corresponds to the Panel PC's rear dimensions (359mm x 194mm) and ensure that the Panel PC can be fitted into the panel properly.

The flat panel thickness is less than 3mm. Be sure to route or trim down the thick wall to 3 mm or slightly less for the clamps to recess and be compatible with your wall or enclosure.

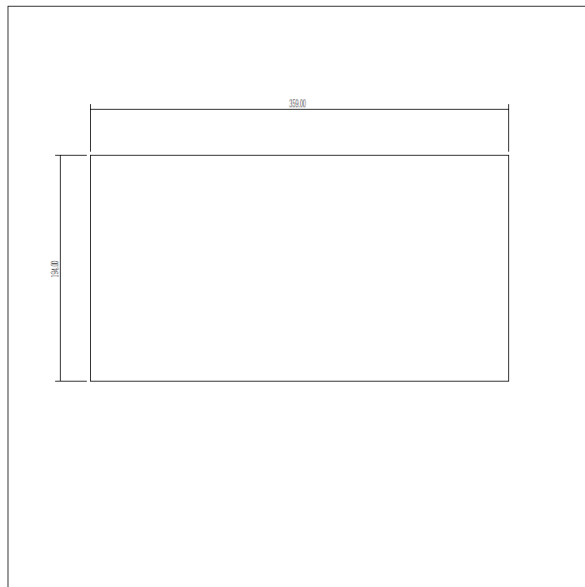

#### Step 3:

Insert the Panel PC from the outside surface of the panel into the mounting hole until it is properly fitted against the panel.

#### Step 4:

Position the mounting clamps along the rear edges of the Panel PC and insert them into the slits around the Panel PC.

#### Step 5:

The first and second clamps must be positioned and secured diagonally prior to mounting the rest of the clamps. Tighten the clamp's screw using an electric screwdriver by pressing the white plastic cap onto the back of the panel. The illustration below shows that all clamps are properly mounted.

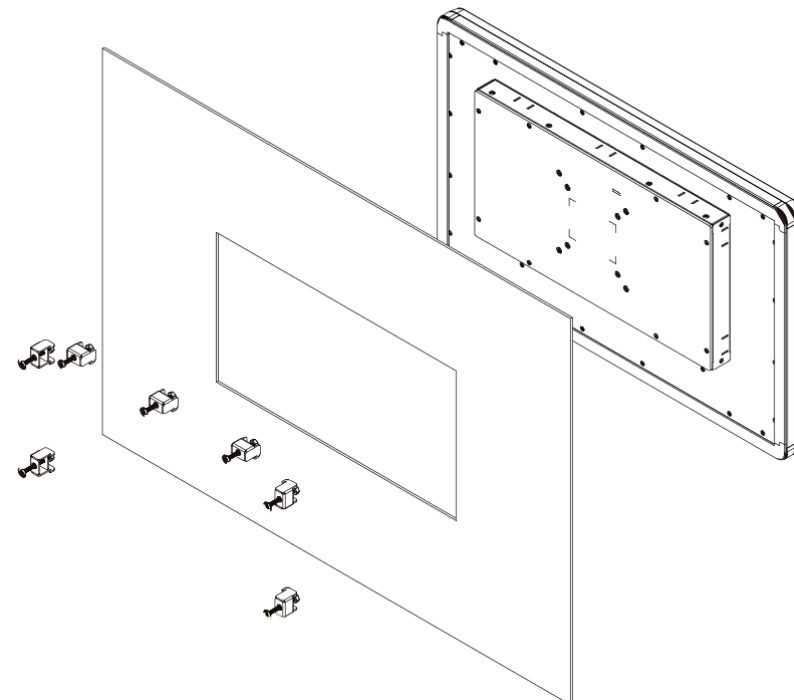



## Chapter 3 - System Settings

### ► System Layout

Top View

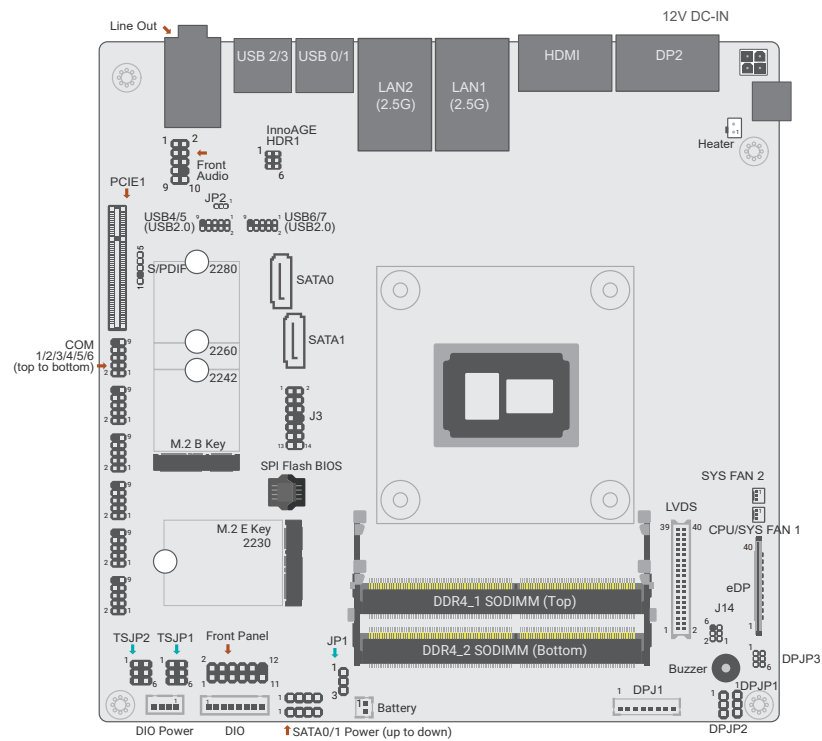

Bottom View

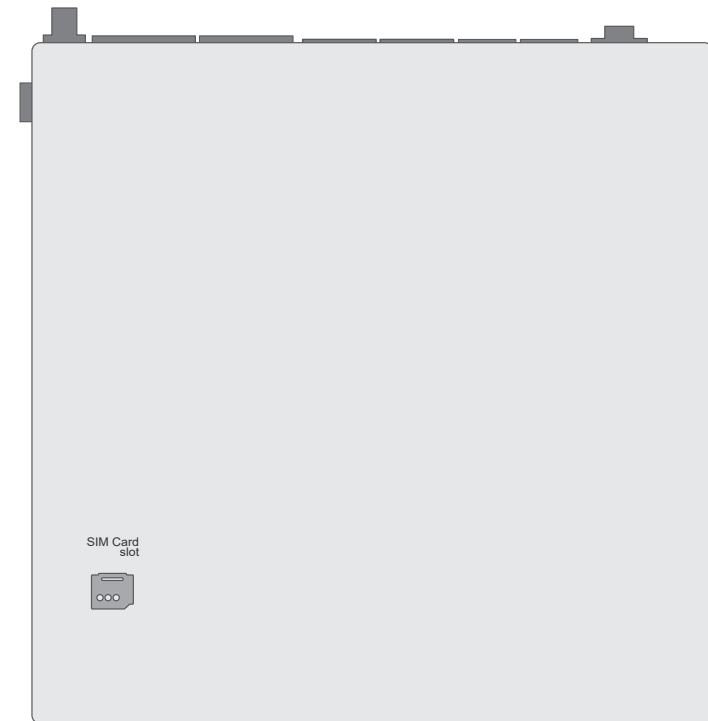

► Jumper Settings

CLEAR CMOS Data

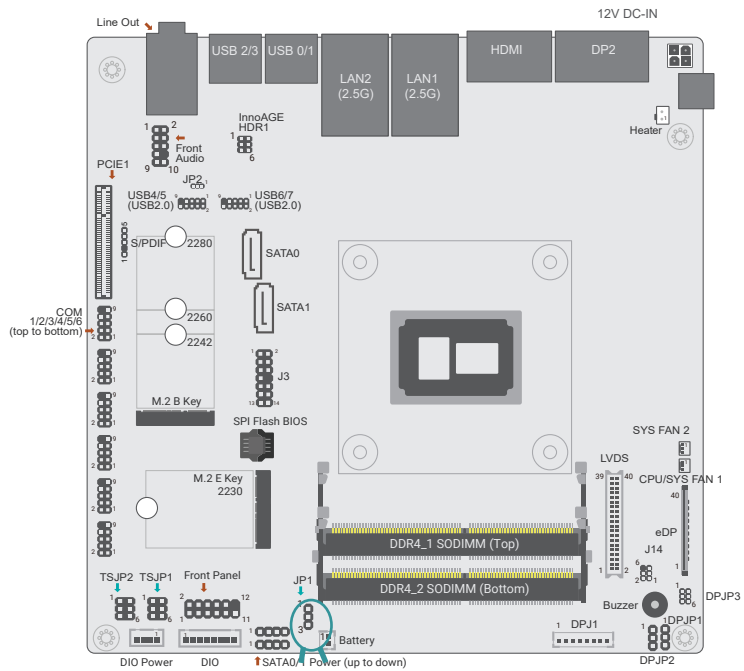

■ 1-2 On: Normal (default)

■ 2-3 On: Clear CMOS Data

Panel Backlight Selection

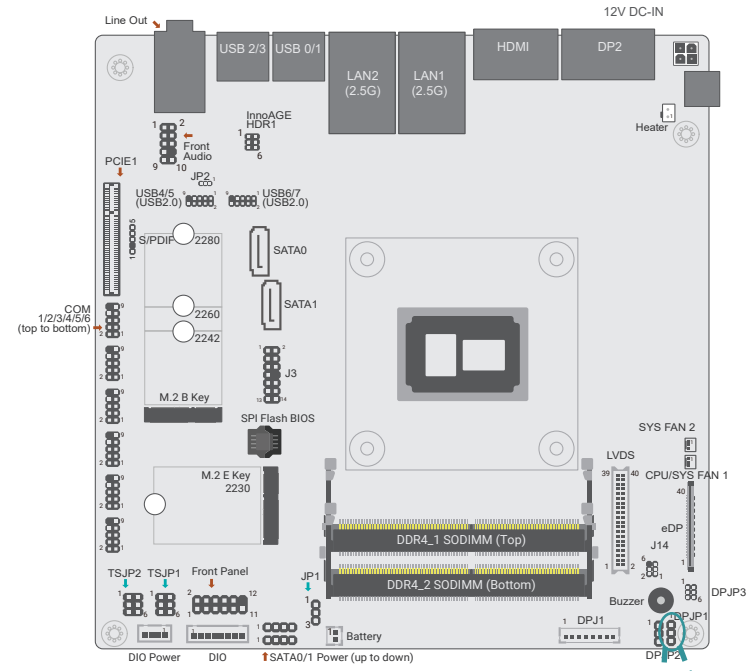

■ 1-2 On: 3.3V (default)

■ 2-3 On: 5V

Panel Inverter Power Selection

Panel VDD Power Jumper

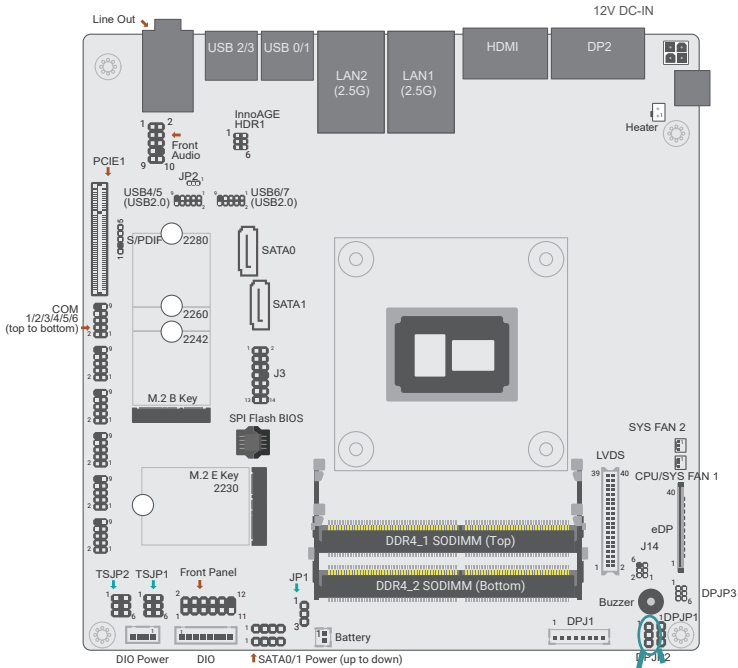

- 1-2 On: 12V (default)
- 2-3 On: 5V

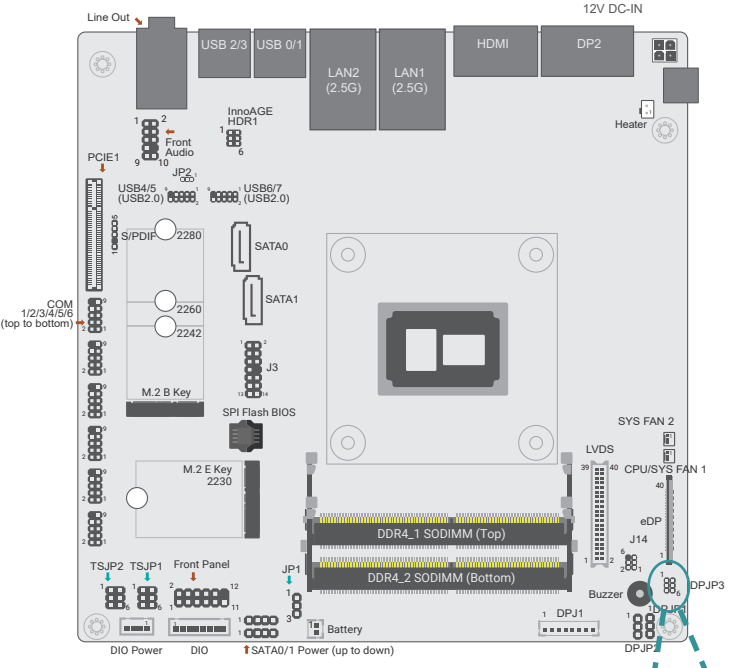

- 1-2 On: 12V
- 3-4 On: 5V
- 5-6 On: 3.3V (default)

### COM1 Power Selection

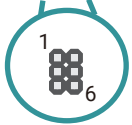
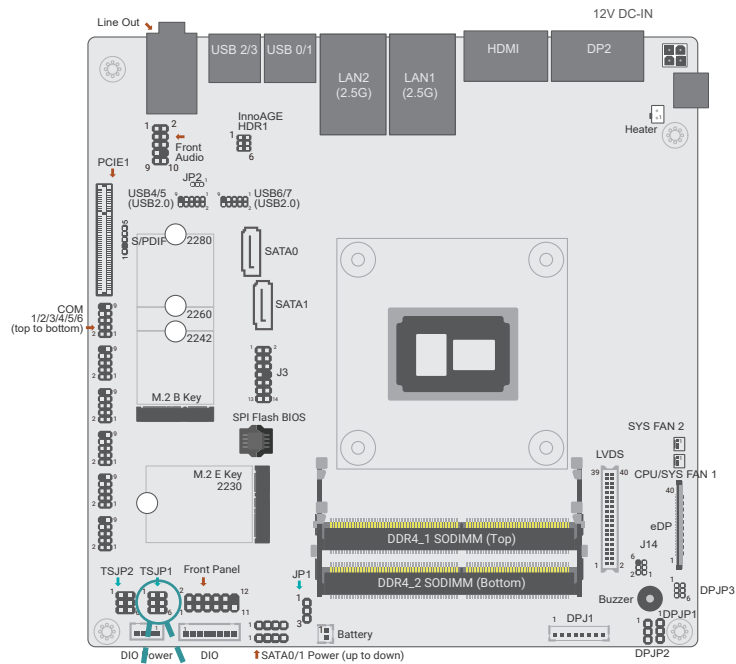

■ 1-3/2-4 On: RS232 Standard (default)

■ 3-5/4-6 On: RS232 With Power

### COM2 Power Selection

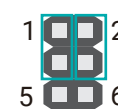
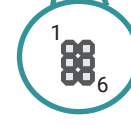
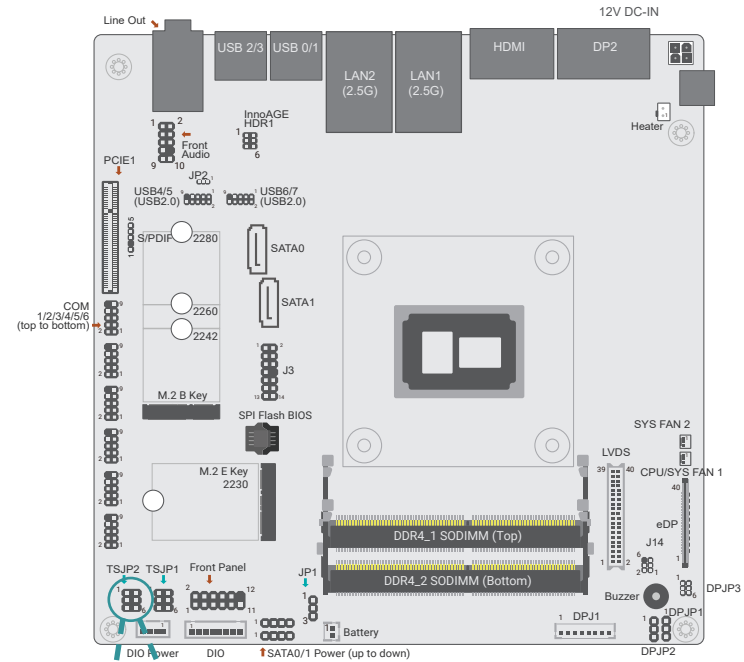

■ 1-3/2-4 On: RS232 Standard (default)

■ 3-5/4-6 On: RS232 With Power

► Pin Assignment

USB Ports

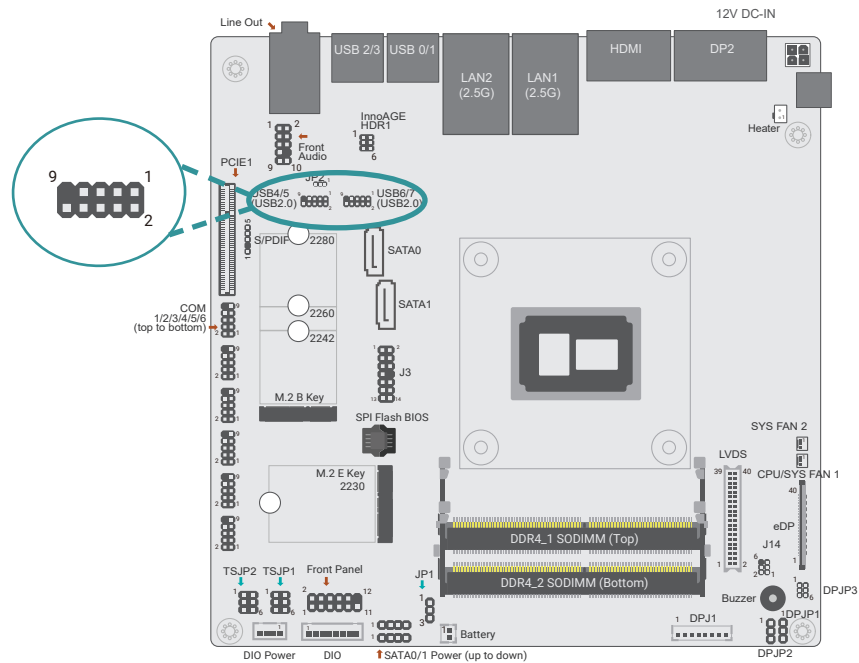

Pin	Function	Pin	Function
1	5V_USB45(67)	2	5V_USB45(67)
3	USB2_4(6)_C_N	4	USB2_5(7)_C_N
5	USB2_4(6)_C_P	6	USB2_5(7)_C_P
7	GND	8	GND
9	---	10	N.C.

Front Audio

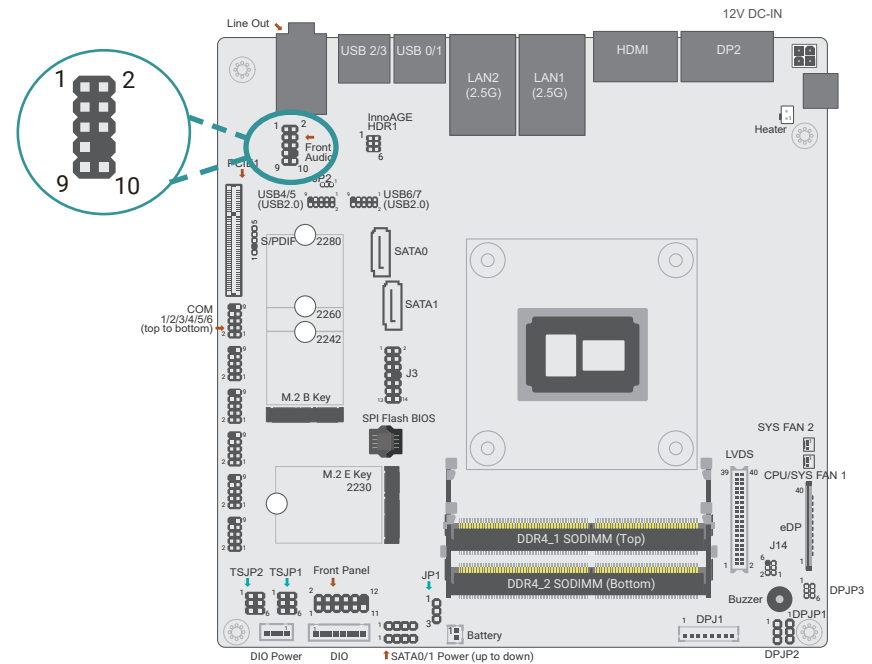

Pin	Function	Pin	Function
1	MIC2-L	2	AGND_AUDIO
3	MIC2-R	4	N.C.
5	LINE2-R	6	MIC2-JD
7	AGND_AUDIO	8	--
9	LINE2-L	10	LINE2-JD

### Digital I/O Connector

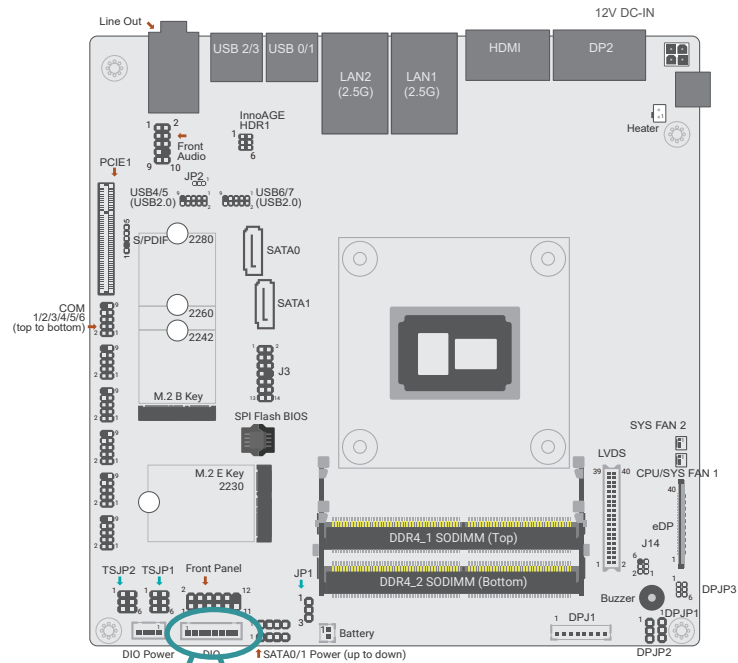

Pin	Function
1	D_IOA0_C
2	D_IOA1_C
3	D_IOA2_C
4	D_IOA3_C
5	D_IOA4_C
6	D_IOA5_C
7	D_IOA6_C
8	D_IOA7_C

### Cooling Fan Connectors

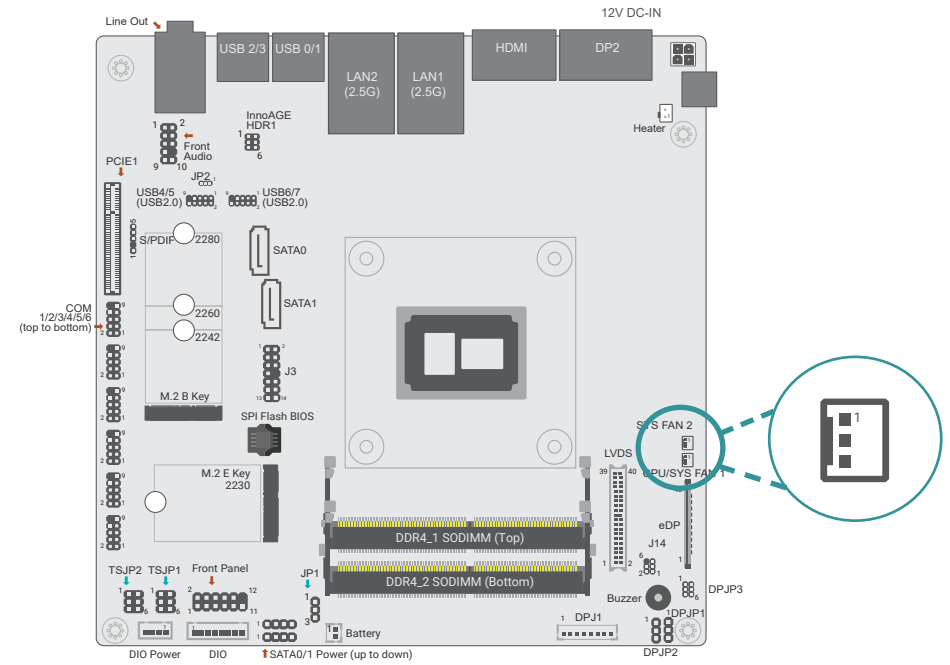

Pin	Function
1	GND
2	PWM
3	TACH

COM (Serial) ports

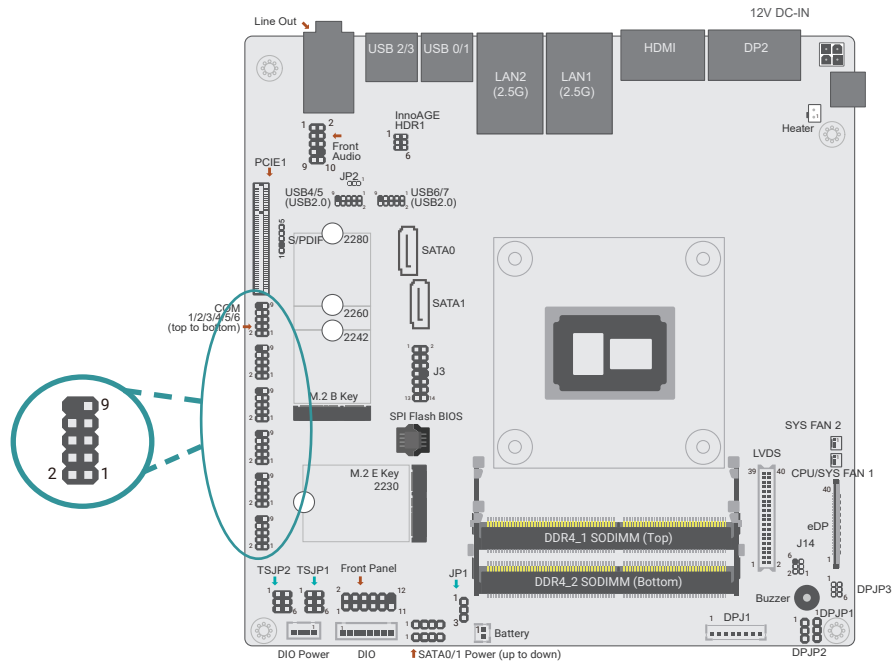

COM1

Pin	Function	Pin	Function
1	X_MDCC1-	2	MSIN1- COM
3	MSO1- COM	4	MDTR1- COM
5	GND	6	MDSR1-
7	MRTS1-	8	MCTS1-
9	X_MRI1-	10	--

COM2

Pin	Function	Pin	Function
1	X_MDCC2-	2	MSIN2- COM
3	MSO2- COM	4	MDTR2- COM
5	GND	6	MDSR2-
7	MRTS2-	8	MCTS2-
9	X_MRI2 -	10	--

COM3

Pin	Function	Pin	Function
1	MDCD3-	2	MSIN3-
3	MSO3-	4	MDTR3-
5	GND	6	MDSR3-
7	MRTS3-	8	MCTS3-
9	MRI3 -	10	--

COM4

Pin	Function	Pin	Function
1	MDCD4-	2	MSIN4-
3	MSO4-	4	MDTR4-
5	GND	6	MDSR4-
7	MRTS4-	8	MCTS4-
9	MRI4 -	10	--

COM5

Pin	Function	Pin	Function
1	MDCD5-	2	MSIN5-
3	MSO5-	4	MDTR5-
5	GND	6	MDSR5-
7	MRTS5-	8	MCTS5-
9	MRI5 -	10	--

COM6

Pin	Function	Pin	Function
1	MDCD6-	2	MSIN6-
3	MSO6-	4	MDTR6-
5	GND	6	MDSR6-
7	MRTS6-	8	MCTS6-
9	MRI6 -	10	--

InnoAGE HDR1

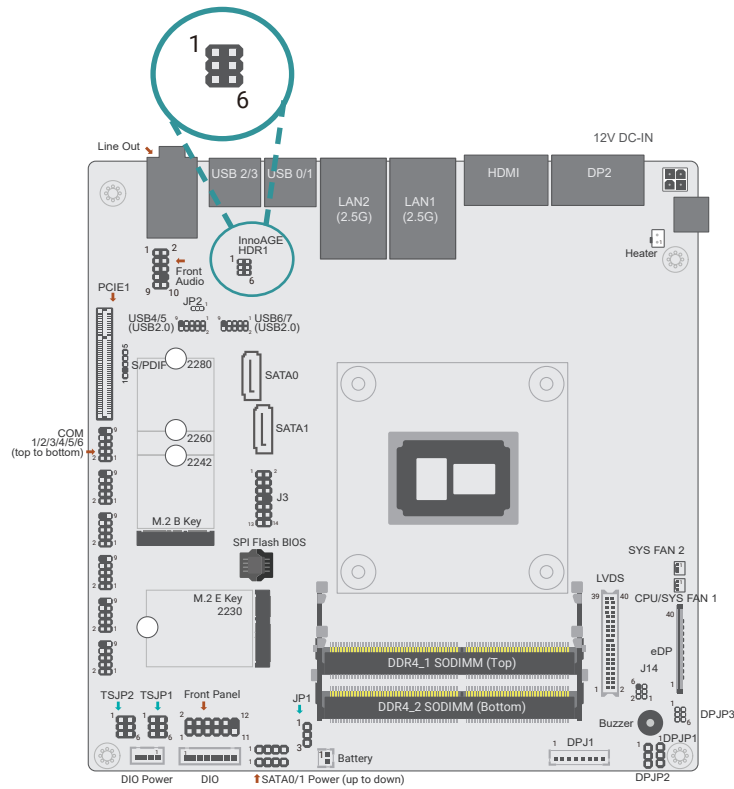

Pin	Function	Pin	Function
1	PM_SYSRST#	2	GP_G14_RECOV#
3	SUS_LED#	4	HD_LED#
5	SIO_PWSIN#	6	GND

COM (Serial) ports

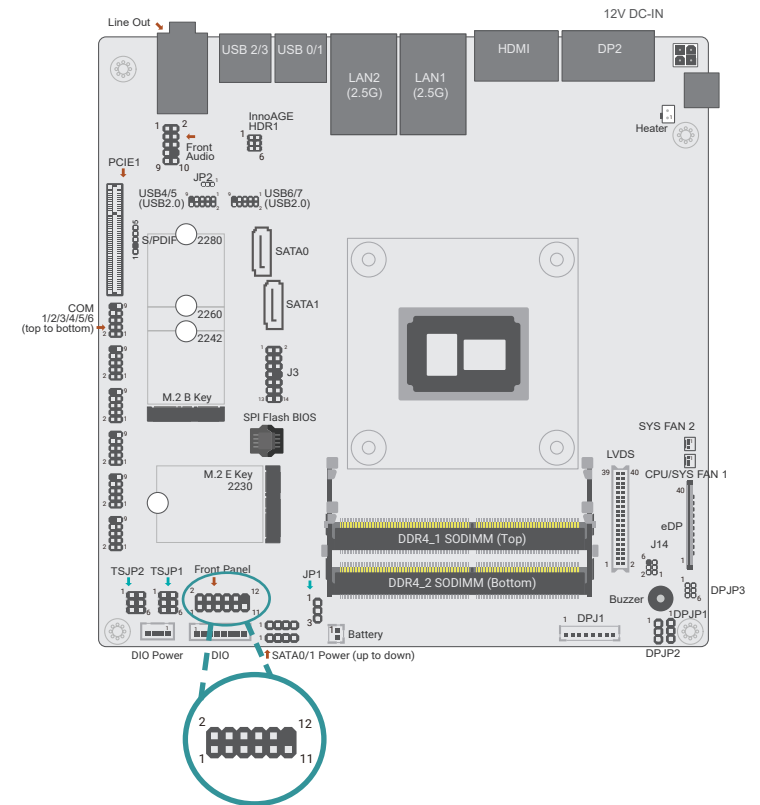

Pin	Function	Pin	Function
1	N.C.	2	3V3SB
3	3V3	4	3V3SB
5	HD_LED#	6	SUS_LED#
7	GND	8	GND
9	PM_SYSRST#	10	SIO_PWSIN#
11	N.C.	12	--



InnoAGE HDR1

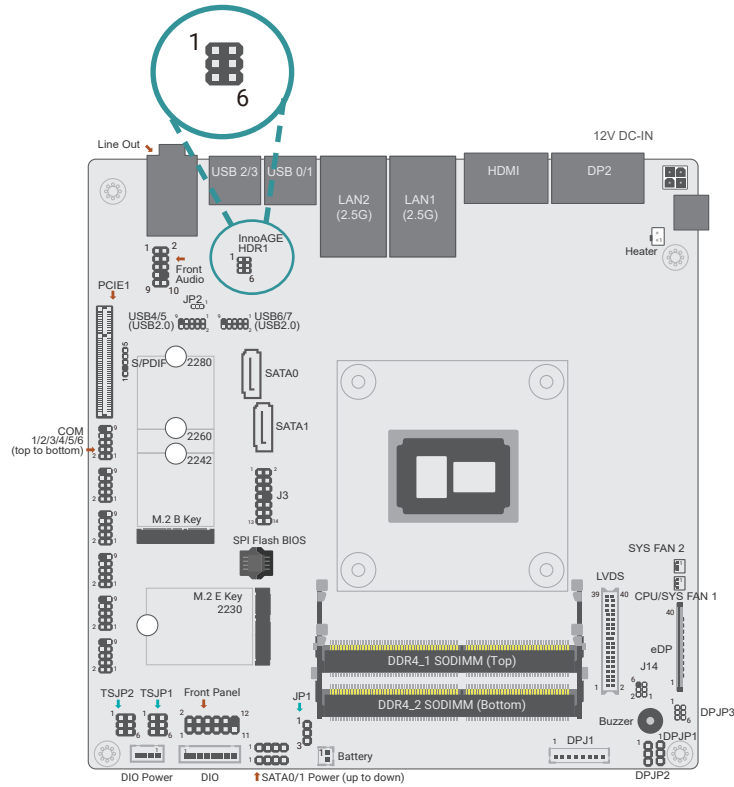

Pin	Function	Pin	Function
1	PM_SYSRST#	2	GP_G14_RECOV#
3	SUS_LED#	4	HD_LED#
5	SIO_PWSIN#	6	GND

Front Panel

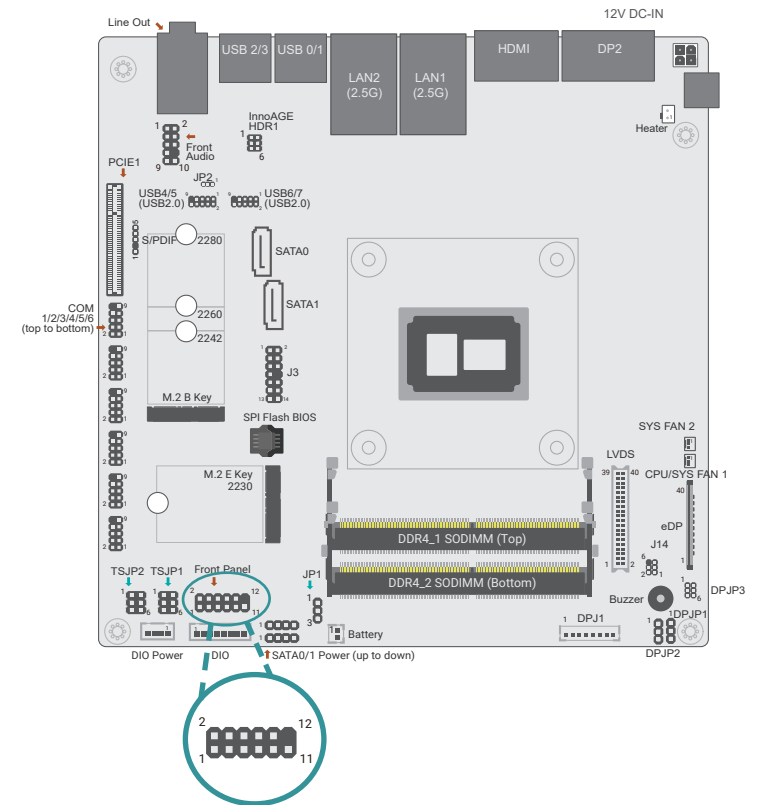

Pin	Function	Pin	Function
1	N.C.	2	3V3SB
3	3V3	4	3V3SB
5	HD_LED#	6	SUS_LED#
7	GND	8	GND
9	PM_SYSRST#	10	SIO_PWSIN#
11	N.C.	12	--

### Battery Header

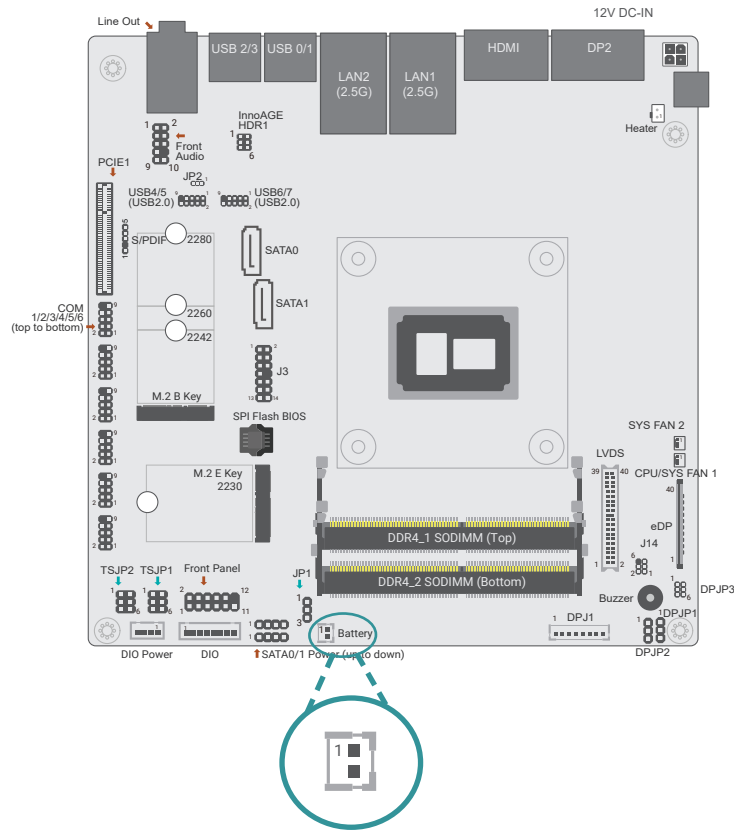

Pin	Function	Pin	Function
1	V_BAT	2	GND

### S/PDIF Connector

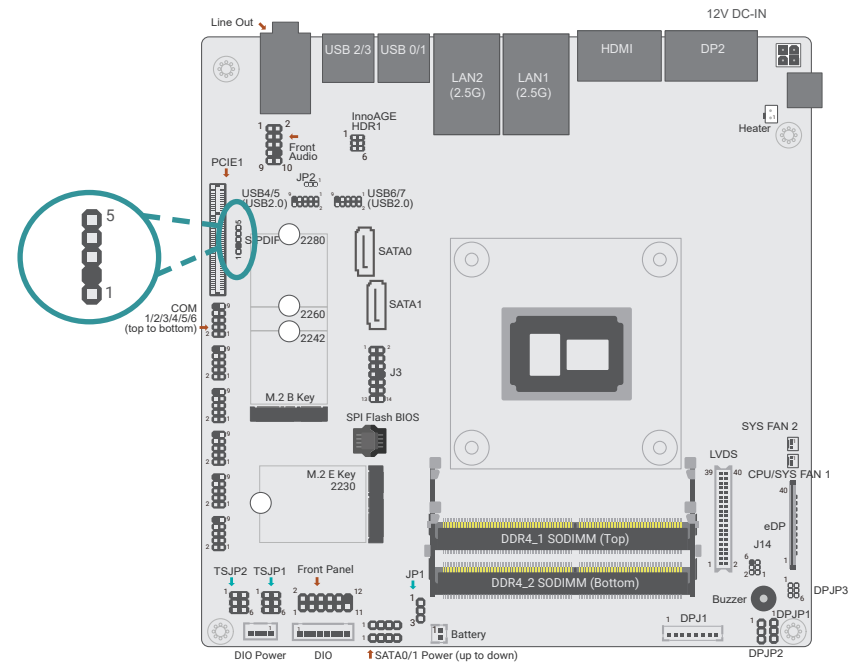

Pin	Function
1	A5V
2	--
3	SPOUT
4	GND
5	SPIN

### DIO Power

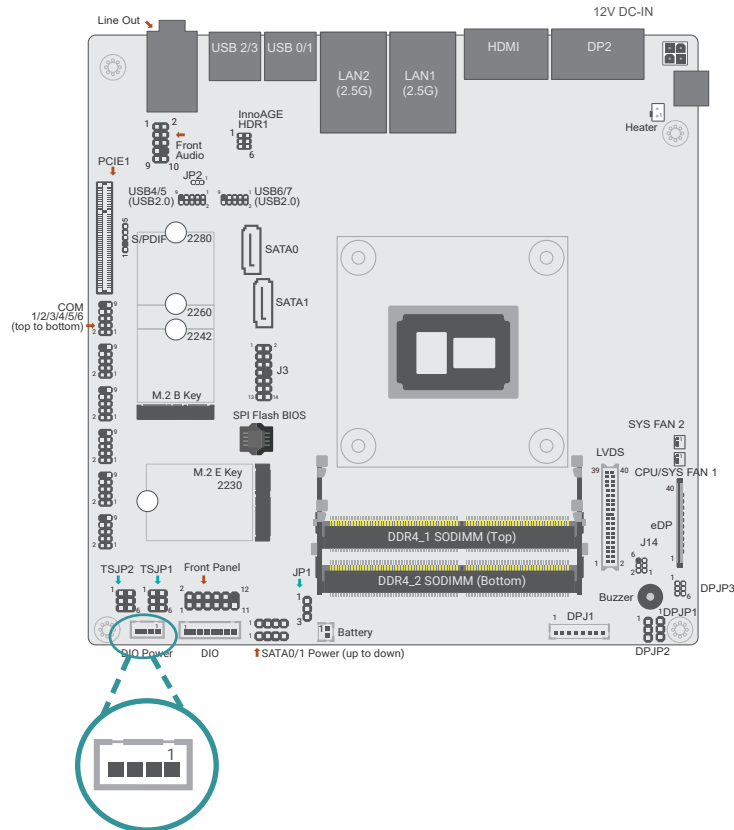

Pin	Function
1	+12V
2	GND
3	5VSB
4	5V

### LVDS Backlight

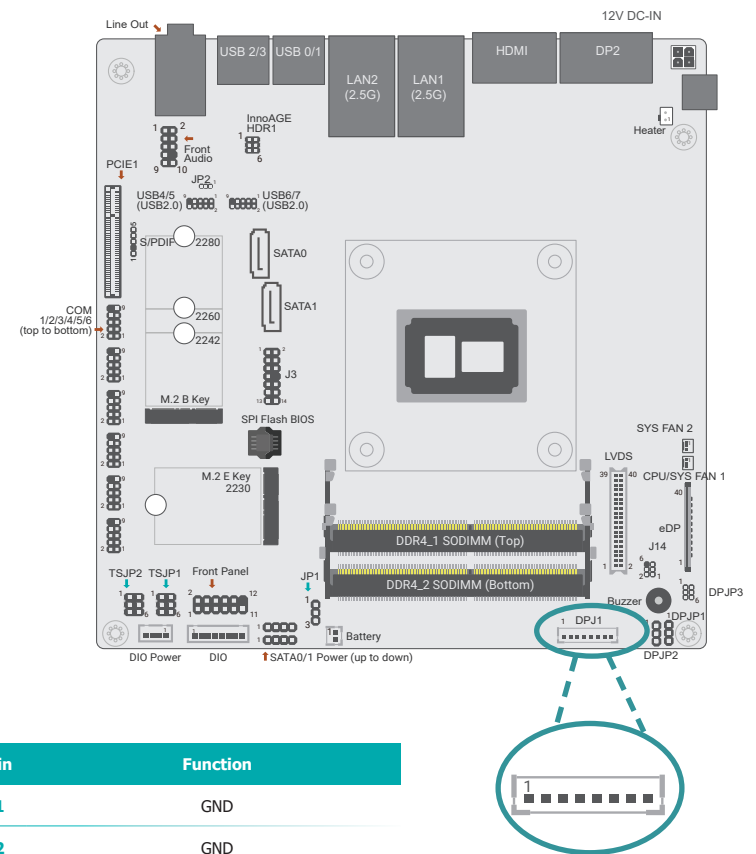

Pin	Function
1	GND
2	GND
3	DIMMING
4	GND
5	LVDS_3V3
6	BLONOFF
7	INV_PWR
8	INV_PWR

### SATA Power

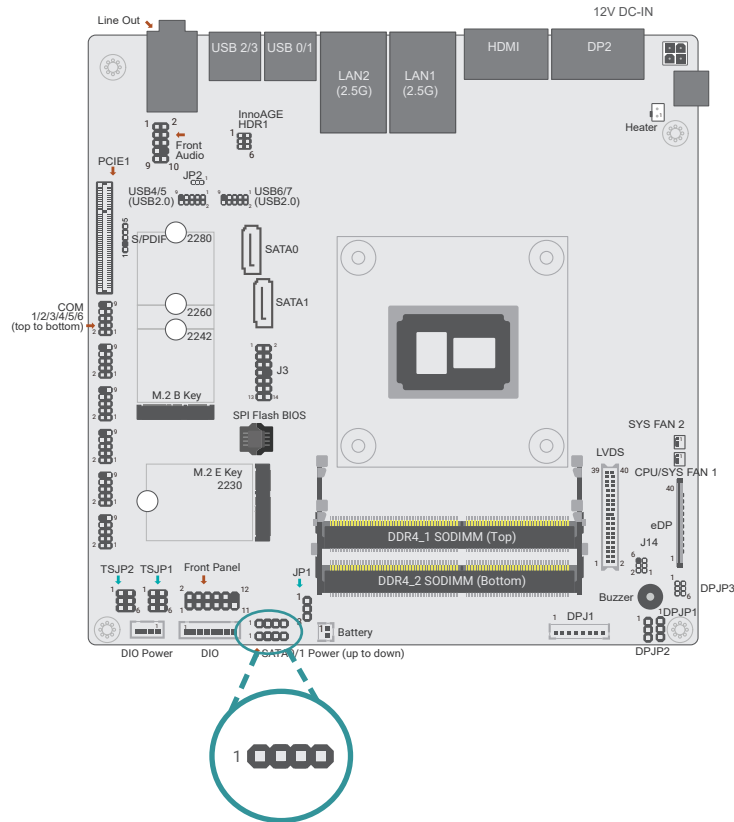

### Heater

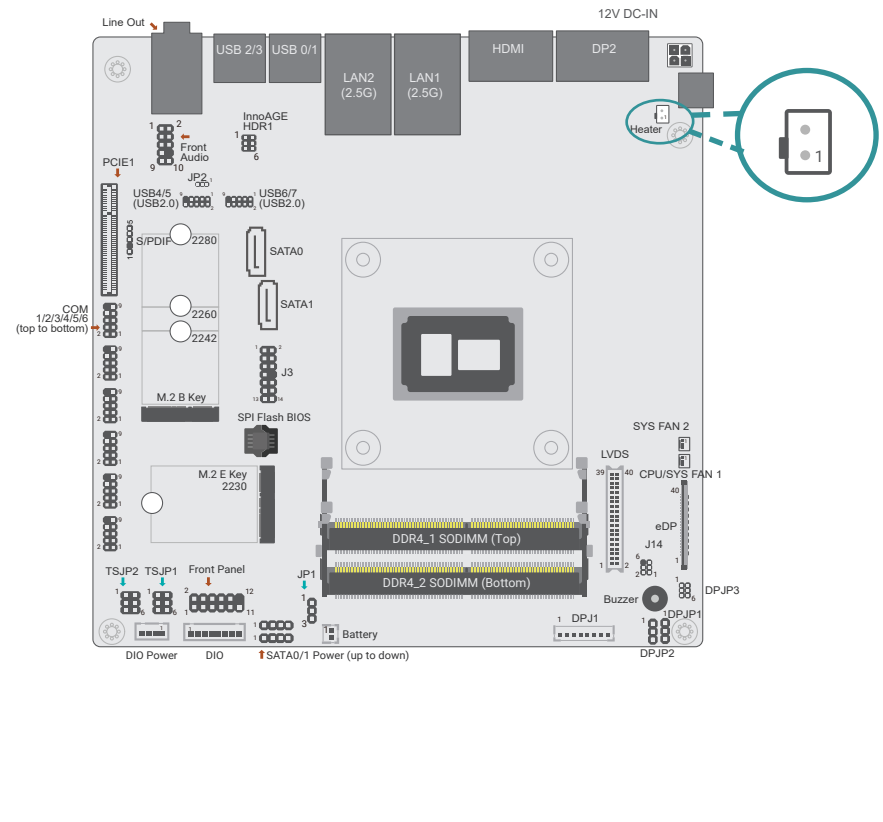

## Chapter 4 - BIOS Settings

### ► Overview

The BIOS is a program that takes care of the basic level of communication between the CPU and peripherals. It contains codes for various advanced features found in this system board. The BIOS allows you to configure the system and save the configuration in a battery-backed CMOS so that the data retains even when the power is off. In general, the information stored in the CMOS RAM of the EEPROM will stay unchanged unless a configuration change has been made such as a hard drive replaced or a device added.

It is possible that the CMOS battery will fail causing CMOS data loss. If this happens, you need to install a new CMOS battery and reconfigure the BIOS settings.



#### Note:

The BIOS is constantly updated to improve the performance of the system board; therefore the BIOS screens in this chapter may not appear the same as the actual one. These screens are for reference purpose only.

#### Default Configuration

Most of the configuration settings are either predefined according to the Load Optimal Defaults settings which are stored in the BIOS or are automatically detected and configured without requiring any actions. There are a few settings that you may need to change depending on your system configuration.

#### Entering the BIOS Setup Utility

The BIOS Setup Utility can only be operated from the keyboard and all commands are keyboard commands. The commands are available at the right side of each setup screen.

The BIOS Setup Utility does not require an operating system to run. After you power up the system, the BIOS message appears on the screen and the memory count begins. After the memory test, the message "Press DEL to run setup" will appear on the screen. If the message disappears before you respond, restart the system or press the "Reset" button. You may also restart the system by pressing the <Ctrl> <Alt> and <Del> keys simultaneously.

#### Legends

Keys	Function
Right / Left arrow	Move the highlight left or right to select a menu
Up / Down arrow	Move the highlight up or down between submenus or fields
<Enter>	Enter the highlighted submenu
+ (plus key)/F6	Scroll forward through the values or options of the highlighted field
- (minus key)/F5	Scroll backward through the values or options of the highlighted field
<F1>	Display general help
<F2>	Display previous values
<F7>	Popup Boot Device List
<F9>	Optimized defaults
<F10>	Save and Exit
<Esc>	Return to previous menu

#### Scroll Bar

When a scroll bar appears to the right of the setup screen, it indicates that there are more available fields not shown on the screen. Use the up and down arrow keys to scroll through all the available fields.

#### Submenu

When "►" appears on the left of a particular field, it indicates that a submenu which contains additional options are available for that field. To display the submenu, move the highlight to that field and press <Enter>.

► Main

The Main menu is the first screen that you will see when you enter the BIOS Setup Utility.

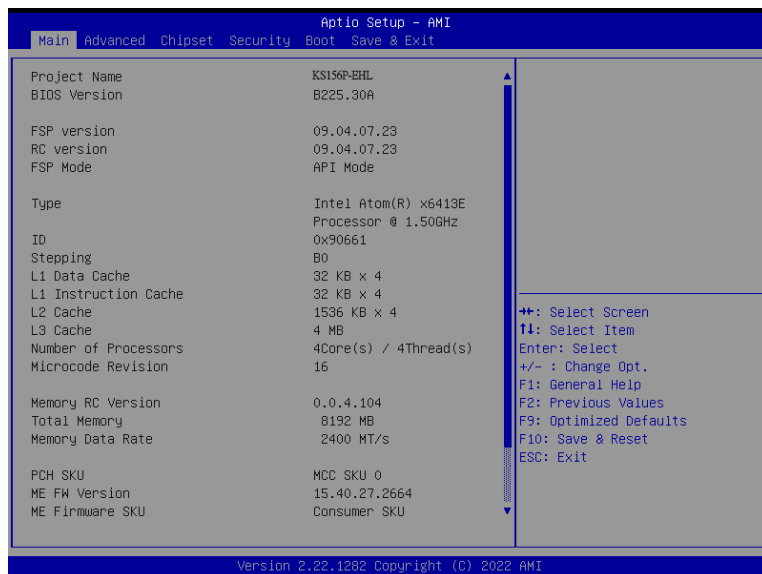

**System Date**

The date format is <month>, <date>, <year>. Press "Tab" to switch to the next field and press "-" or "+" to modify the value.

**System Time**

The time format is <hour>, <minute>, <second>. The time is based on the 24-hour military-time clock. For example, 1 p.m. is 13:00:00. Hour displays hours from 00 to 23. Minute displays minutes from 00 to 59. Second displays seconds from 00 to 59.

► Advanced

The Advanced menu allows you to configure your system for basic operation. Some entries are defaults required by the system board, while others, if enabled, will improve the performance of your system or let you set some features according to your preference.



**Important:**  
Setting incorrect field values may cause the system to malfunction.

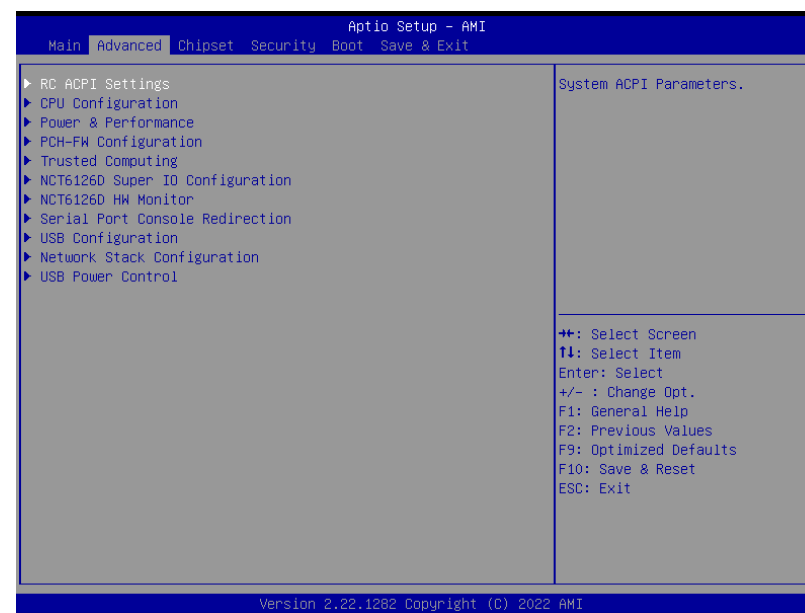

▶ Advanced

RC ACPI Settings

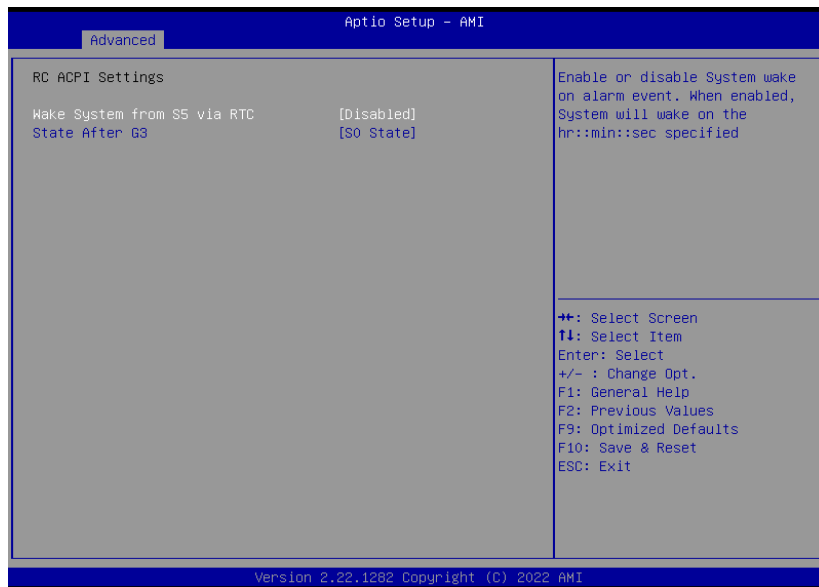

**Wake system from S5 via RTC**

When Enabled, the system will automatically power up at a designated time every day. Once it's switched to [Enabled], please set up the time of day – hour, minute, and second – for the system to wake up.

**State After G3**

Select between S0 State, and S5 State. This field is used to specify what state the system is set to return to when power is re-applied after a power failure (G3 state).

- **S0 State** The system automatically powers on after power failure.
- **S5 State** The system enter soft-off state after power failure. Power-on signal input is required to power up the system.
- **Last State** The system returns to the last state right before power failure.

▶ Advanced

CPU Configuration

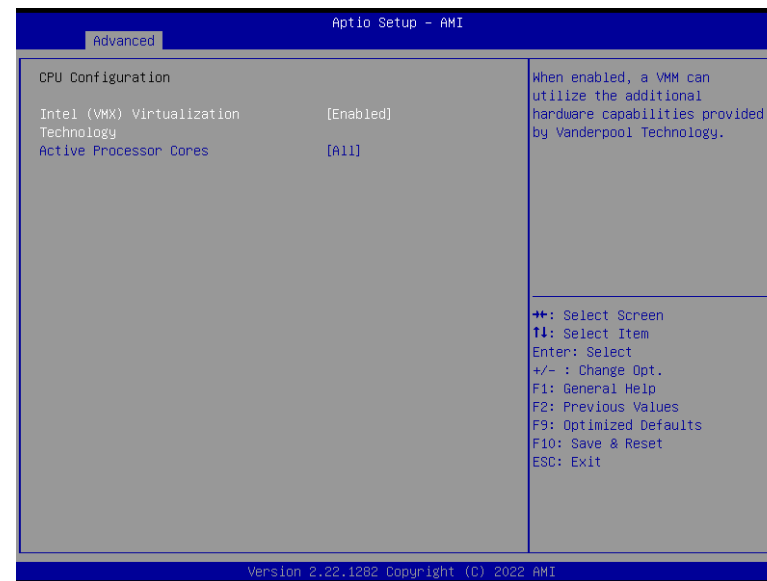

**Intel (VMX) Virtualization Technology**

When this field is set to Enabled, the VMM can utilize the additional hardware capabilities provided by Vanderpool Technology.

**Active Processor Cores**

Select number of cores to enable in each processor package: all or 1.

▶ Advanced

Power & Performance

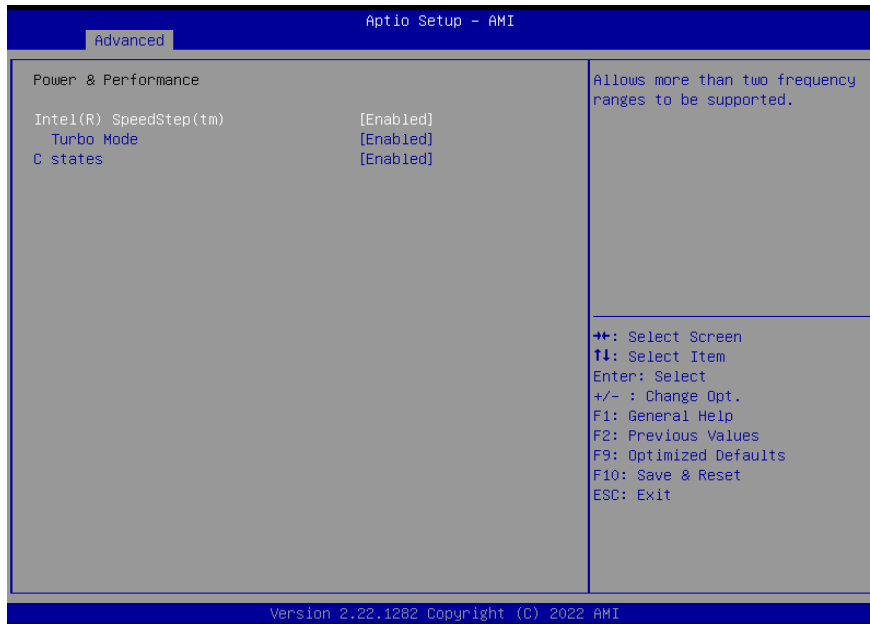

**Intel (R) SpeedStep(tm)**

This field is used to enable or disable the Intel SpeedStep® Technology, which helps optimize the balance between system's power consumption and performance. After it is enabled in the BIOS, EIST features can then be enabled via the operating system's power management.

**Turbo Mode**

Enable or disable turbo mode of the processor. This field will only be displayed when EIST is enabled.

**C states**

Enable or disable CPU Power Management. It allows CPU to enter "C states" when it's idle and nothing is executing.

▶ Advanced

PCH-FW Configuration

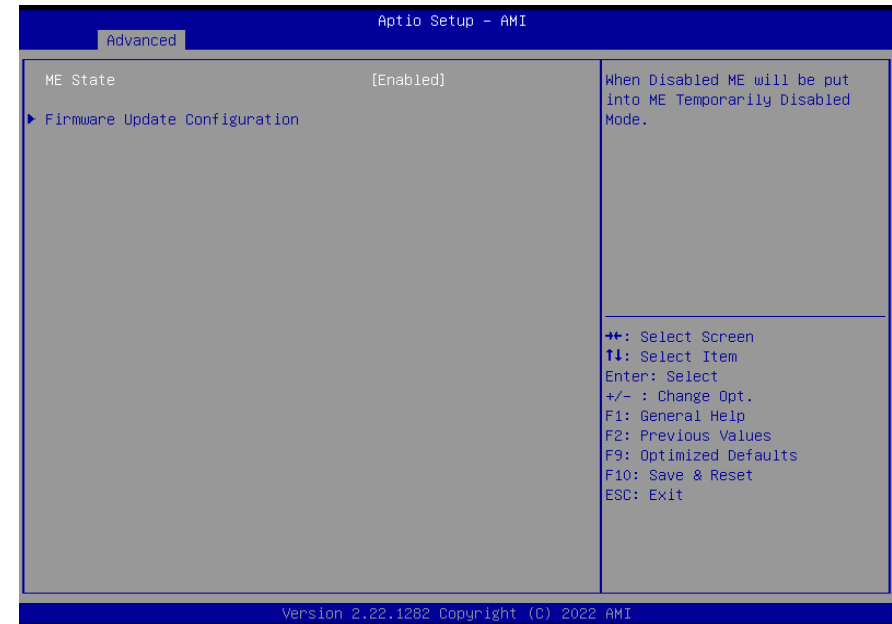

**ME State**

When this field is set to Disabled, ME will be put into ME Temporarily Disabled Mode.



▶ Advanced

### Trusted Computing



#### Security Device Support

This field is used to enable or disable BIOS support for the security device such as an TPM 2.0 to achieve hardware-level security via cryptographic keys.

#### Pending operation

To clear the existing TPM encryption, select "TPM Clear" and restart the system. This field is not available when "Security Device Support" is disabled.

▶ Advanced

### NCT6126D Super IO Configuration

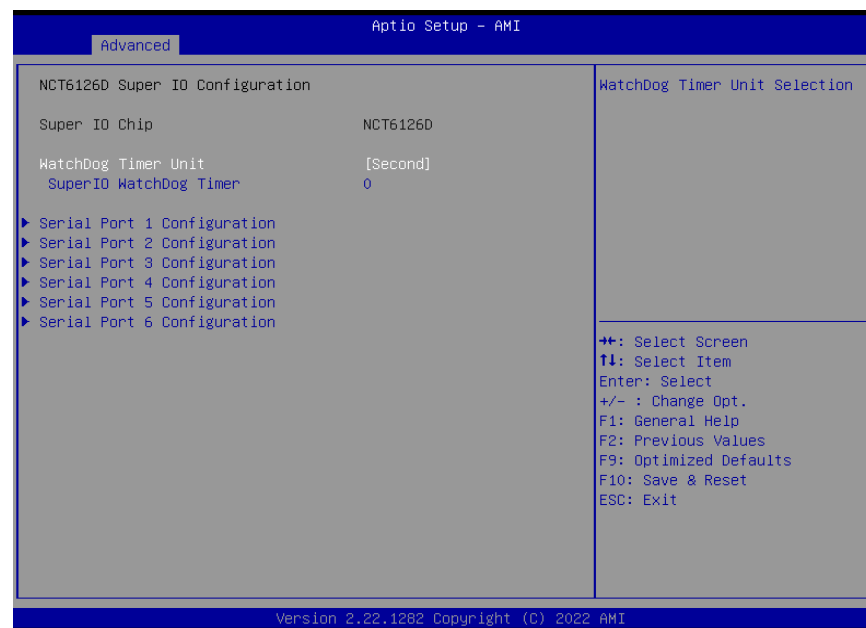

#### WatchDog Timer Unit

Select WatchDog Timer Unit – Second or Minute.

#### SuperIO WatchDog Timer

Set SuperIO WatchDog Timer Timeout value. The range is from 0 (disabled) to 255.



**Note:**  
The sub-menus are detailed in following sections.

► Advanced

NCT6126D Super IO Configuration ► Serial Port 1, 2 Configuration

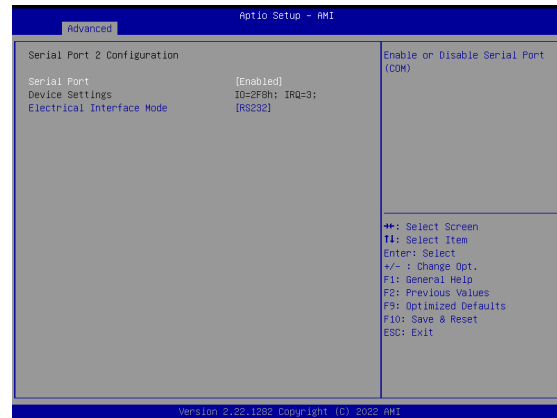

**Serial Port**

Enable or disable serial port.

NCT6126D Super IO Configuration ► Serial Port 3, 4 Configuration

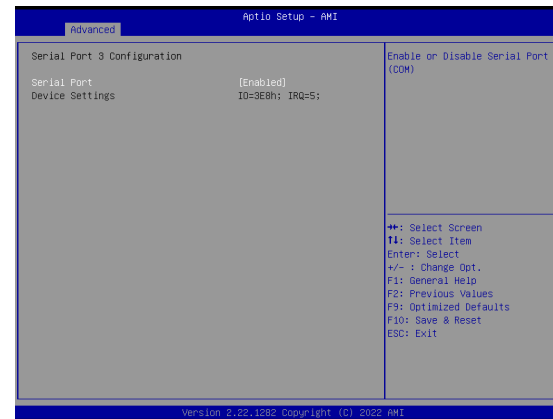

**Serial Port**

Enable or disable serial port.

NCT6126D Super IO Configuration ▶ Serial Port 5, 6 Configuration

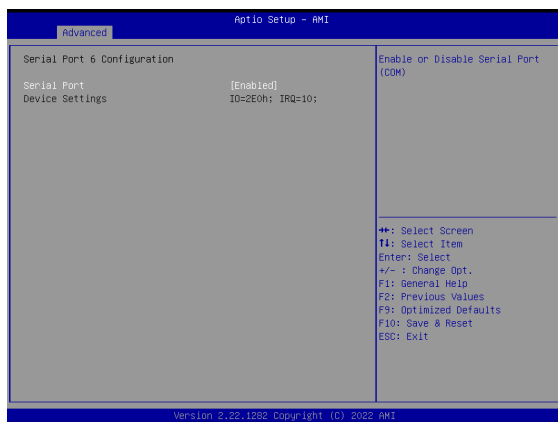
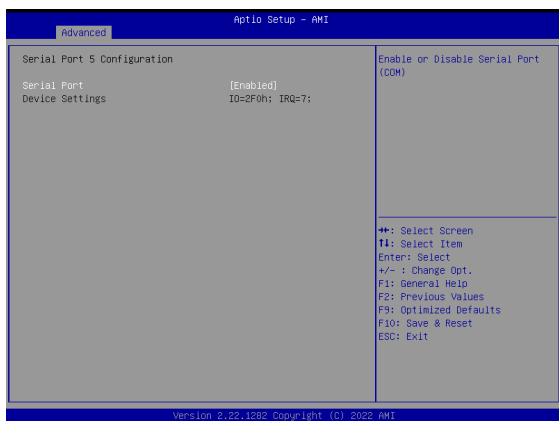

**Serial Port**

Enable or disable serial port.

▶ Advanced

NCT6126D HW Monitor

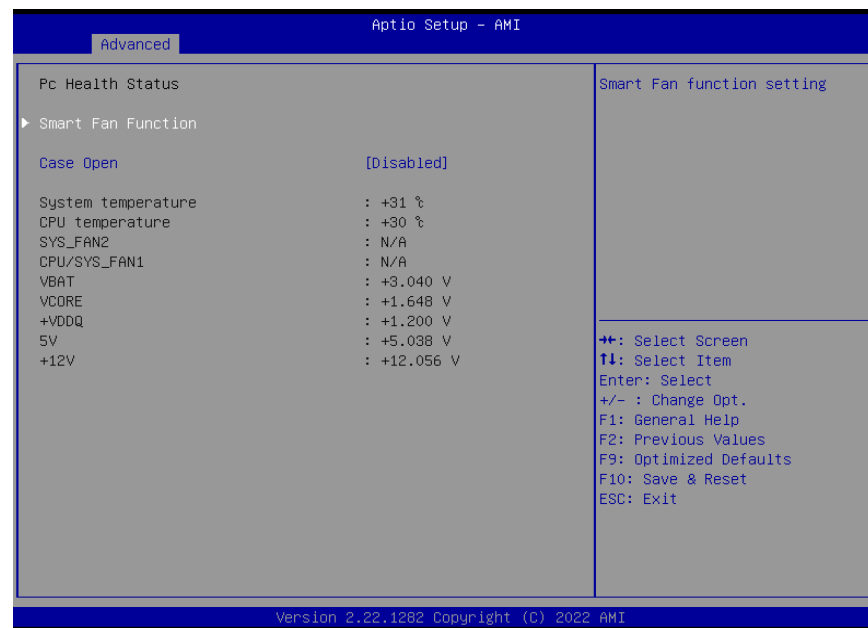

This section displays the system's health information, i.e. voltage readings, CPU and system temperatures, and fan speed readings

**Case Open**

Enable or disable the case open detection function.

▶ Advanced

Smart Fan Function

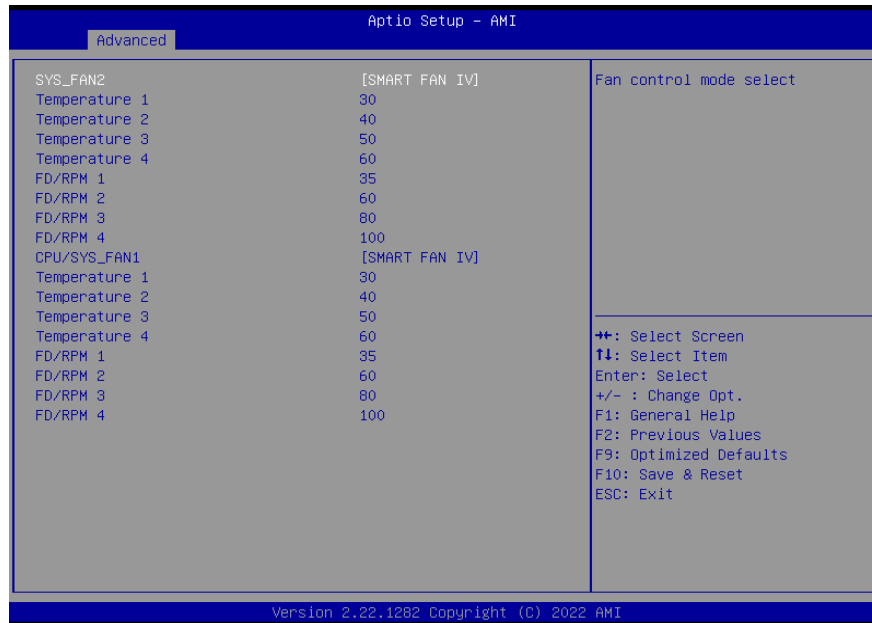

Smart Fan is a fan speed moderation strategy dependent on the current system temperature. When the system temperature goes higher than the Boundary setting, the fan speed will be turned up to the setting of the Fan Speed Count that bears the same index as the Boundary field.

▼ SYS Fan2 = [SMART FAN IV] or [Manual Mode]

Temperature 1 to Temperature 4

The value of temperature 1~4.

FD/RPM 1 to FD/RPM 4

The value of Fan Duty/RPM when temperature T1~T4.

▼ CPU/SYS\_Fan1 = [SMART FAN IV] or [Manual Mode]

Temperature 1 to Temperature 4

The value of temperature 1~4.

FD/RPM 1 to FD/RPM 4

The value of Fan Duty/RPM when temperature T1~T4.

▶ Advanced

Serial Port Console Redirection

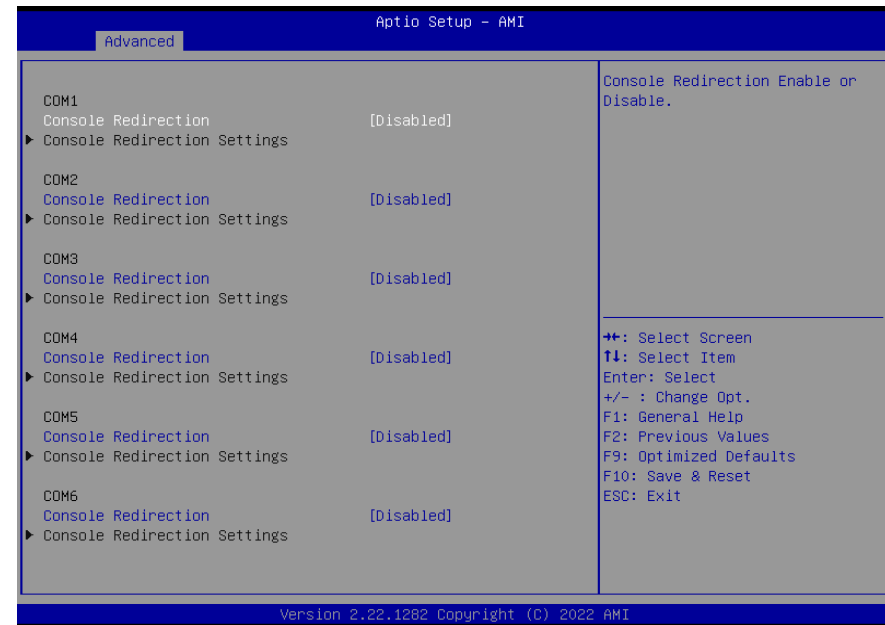

Console Redirection

By enabling Console Redirection of a COM port, the sub-menu of console redirection settings will become available for configuration as detailed in the following.

► Advanced

Serial Port Console Redirection ► Console Redirection Settings



Configure the serial settings of the current COM port.

**Terminal Type**

Select terminal type: VT100, VT100+, VT-UTF8 or ANSI.

**Bits per second**

Select serial port transmission speed: 9600, 19200, 38400, 57600 or 115200.

**Data Bits**

Select data bits: 7 bits or 8 bits.

**Parity**

Select parity bits: None, Even, Odd, Mark or Space.

**Stop Bits**

Select stop bits: 1 bit or 2 bits.

**Flow Control**

Select flow control type: None or Hardware RTS/CTS. Flow Control is for RS485 mode and is only supported by Serial Port 1 (COM1).

► Advanced

USB Configuration

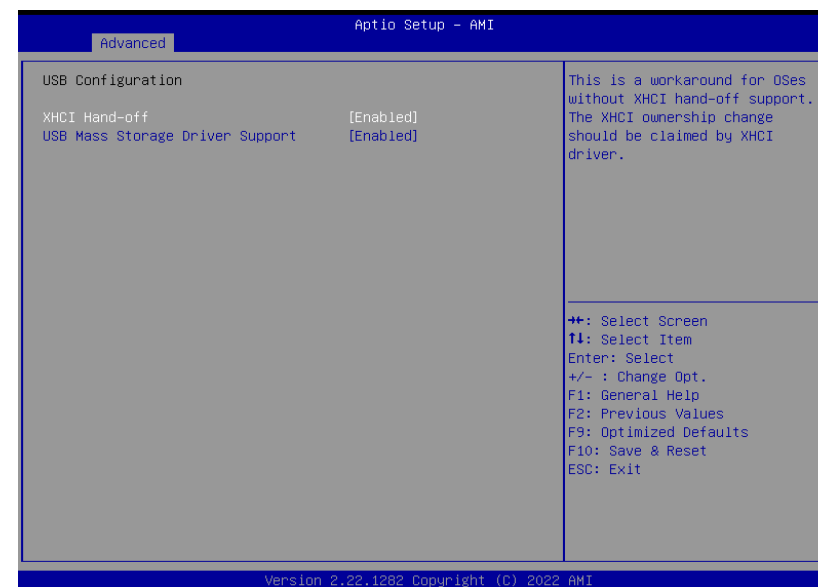

**XHCI Hand-off**

Enable or disable XHCI Hand-off.

**USB Mass Storage Driver Support**

Enable or disable USB Mass Storage Driver Support.

► Advanced

### Network Stack Configuration



#### Network Stack

Enable or disable UEFI network stack. The following fields will appear when this field is enabled.

#### IPv4 PXE Support

Enable or disable IPv4 PXE boot support. If disabled, IPv4 PXE boot support will not be available.

#### IPv6 PXE Support

Enable or disable IPv6 PXE boot support. If disabled, IPv6 PXE boot support will not be available.

#### PXE boot wait time

Set the wait time in seconds to press ESC key to abort the PXE boot. Use either +/- or numeric keys to set the value.

#### Media detect count

Set the number of times the presence of media will be checked. Use either +/- or numeric keys to set the value.

► Advanced

### USB Power Control

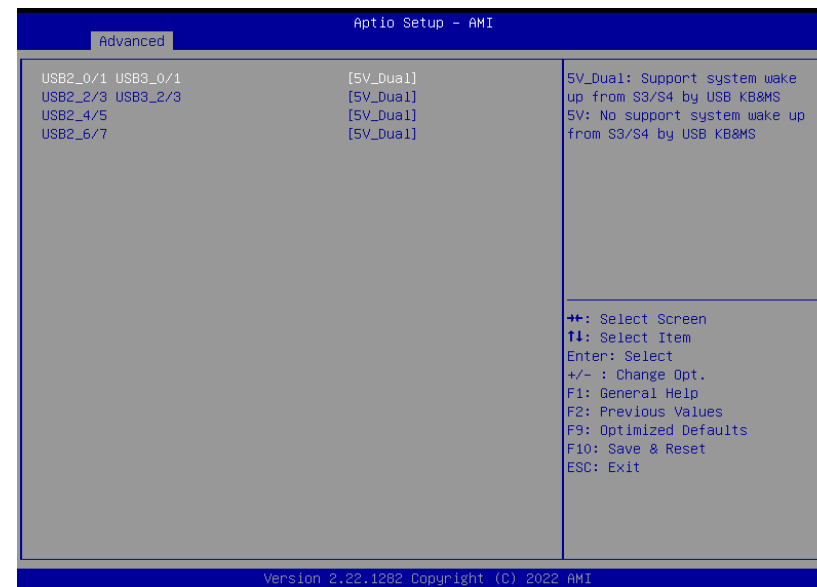

#### Server CA Configuration

**5\_Dual:** Support system wake up from S3/S4 by USB KB&MS

**5V:** No support system wake up from S3/S4 by USB KB&MS

► Chipset

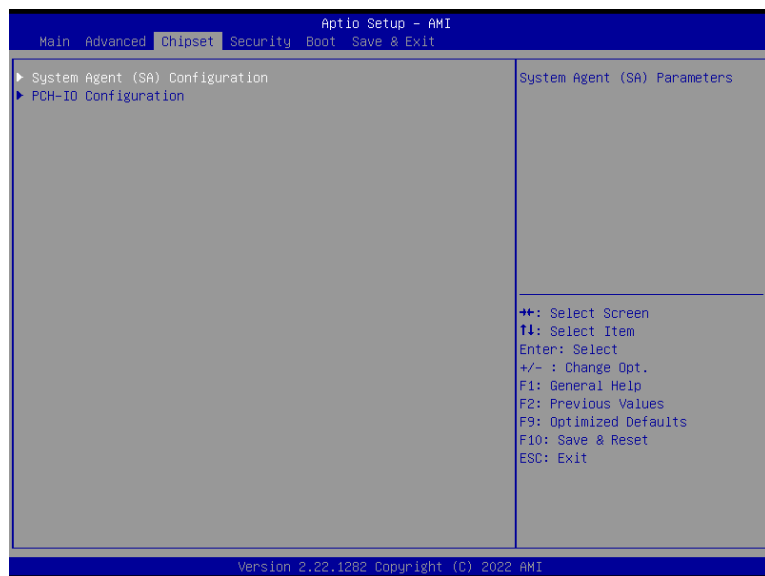

Please select a submenu and press Enter. The submenus are detailed in the following pages.

► Chipset

System Agent (SA) Configuration

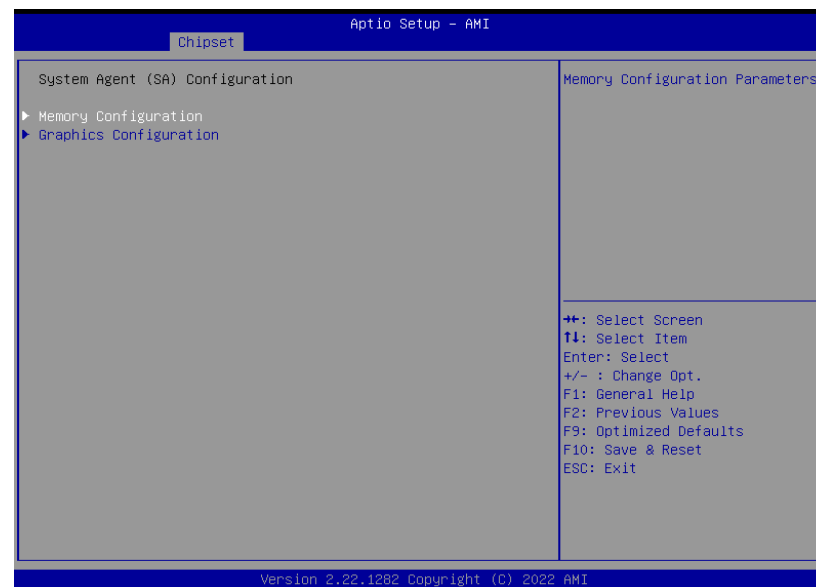

**Memory Configuration**

Memory Configuration Parameters

**Graphics Configuration**

Graphics Configuration Parameters

► Chipset

PCH-IO Configuration

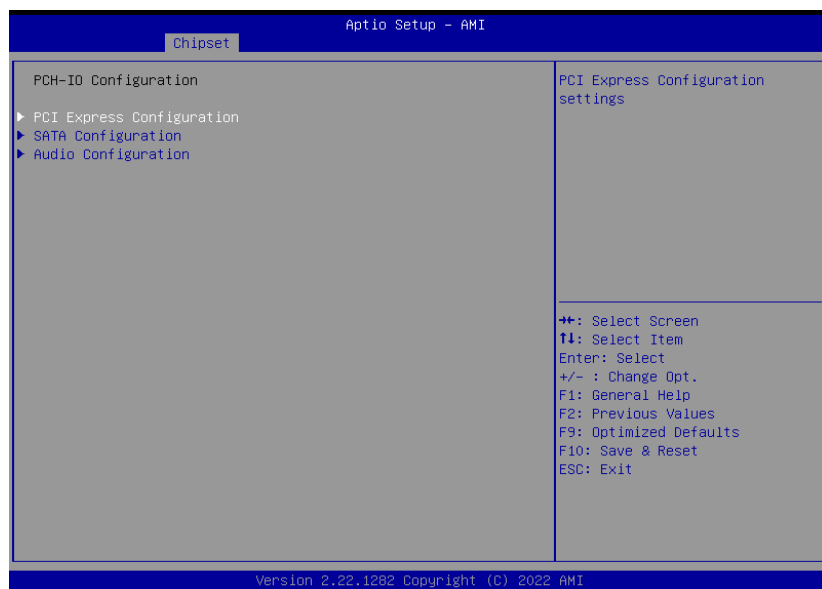

**PCI Express Configuration**

PCI Express Configuration Settings

**SATA Configuration**

SATA Device Options Settings

**Audio Configuration**

Audio Subsystem Configuration Settings

► Chipset

PCH-IO Configuration ► PCI Express Configuration



Select one of the PCI Express channels and press enter to configure the following settings.

**PCIe1, 2.5G-LAN 1, 2.5G-LAN 2, M.2-E, M.2-B**

Control the PCI Express Root Port.



► Chipset

PCH-IO Configuration ► SATA Configuration



**SATA Controller(s)**

This field is used to enable or disable the Serial ATA controller.

**SATA Mode Selection**

The mode selection determines how the SATA controller(s) operates.

- **AHCI** This option allows the Serial ATA controller(s) to use AHCI (Advanced Host Controller Interface).
- **Intel RST Premium With Intel Optane System Acceleration** This option allows you to create RAID or Intel Rapid Storage configuration along with Intel® Optane™ system acceleration on Serial ATA devices.

**Ports**

Enable or disable the Serial ATA port.

► Chipset

PCH-IO Configuration ► Audio Configuration



**HD Audio**

Control the detection of the Audio device.

- **Disabled** HDA will be unconditionally disabled.
- **Enabled** HDA will be unconditionally enabled.

## ► Security

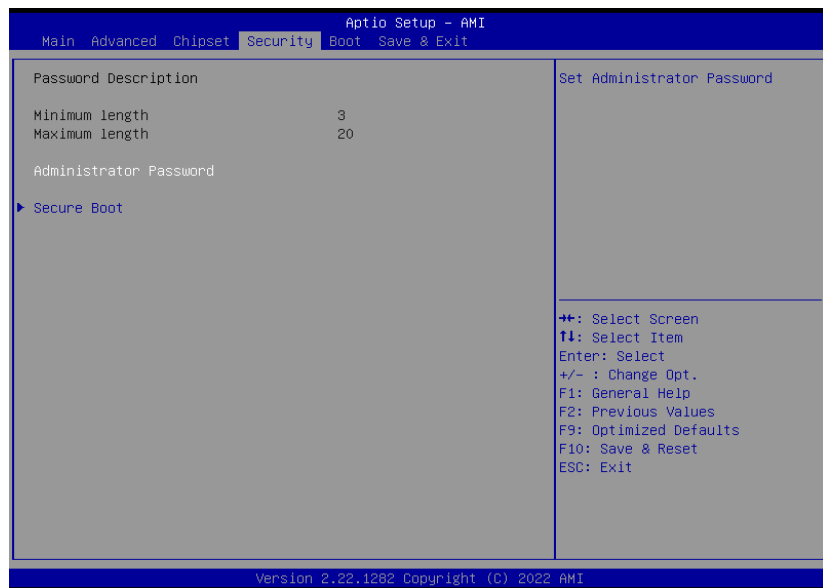
**Administrator Password**

Set the administrator password. To clear the password, input nothing and press enter when a new password is asked. Administrator Password will be required when entering the BIOS.

**User Password**

Set the user password. To clear the password, input nothing and press enter when a new password is asked. User Password will be required when powering up the system.

## ► Security

## Secure Boot

**Secure Boot**

The Secure Boot store a database of certificates in the firmware and only allows the OSEs with authorized signatures to boot on the system. To activate Secure Boot, please make sure that "Secure Boot" is "[Enabled]", Platform Key (PK) is enrolled, "System Mode" is "User", and CSM is disabled. After enabling/disabling Secure Boot, please save the configuration and restart the system. When configured and activated correctly, the Secure Boot status will be "Active".

**Secure Boot Mode**

Select the secure boot mode – Standard or Custom. When set to Custom, the following fields will be configurable for the user to manually modify the key database.

**Restore Factory Keys**

Force system to User Mode. Load OEM-defined factory defaults of keys and databases onto the Secure Boot. Press Enter and a prompt will show up for you to confirm.

**Reset To Setup Mode**

Clear the database from the NVRAM, including all the keys and signatures installed in the Key Management menu. Press Enter and a prompt will show up for you to confirm.

**Key Management**

Enable expert users to modify Secure Boot Policy variables without full authentication.

► Boot

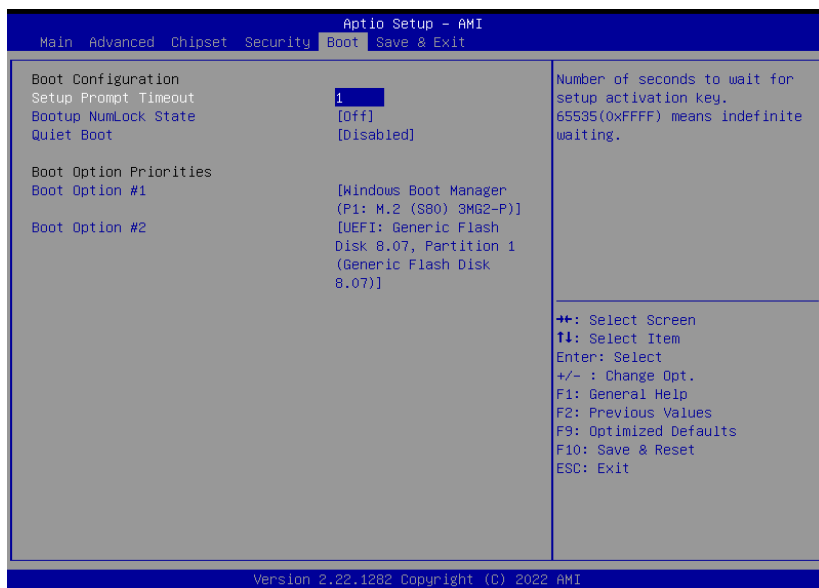

**Setup Prompt Timeout**

Set the number of seconds to wait for the setup activation key. 65535 (0xFFFF) denotes indefinite waiting.

**Bootup NumLock State**

Select the keyboard NumLock state: On or Off.

**Quiet Boot**

This section is used to enable or disable quiet boot option.

**Boot Option Priorities**

Rearrange the system boot order of available boot devices.

**BGRT Logo**

It is used to enable or disable to support display logo with ACPI BGRT table.



**Note:**

If "Boot option filter" of "CSM Configuration" is set to "UEFI and Legacy" or "UEFI only", and "Quiet Boot" is set to enabled, "BGRT Logo" will show up for configuration. Refer to the Advanced > CSM Configuration submenu for more information.

► Save & Exit

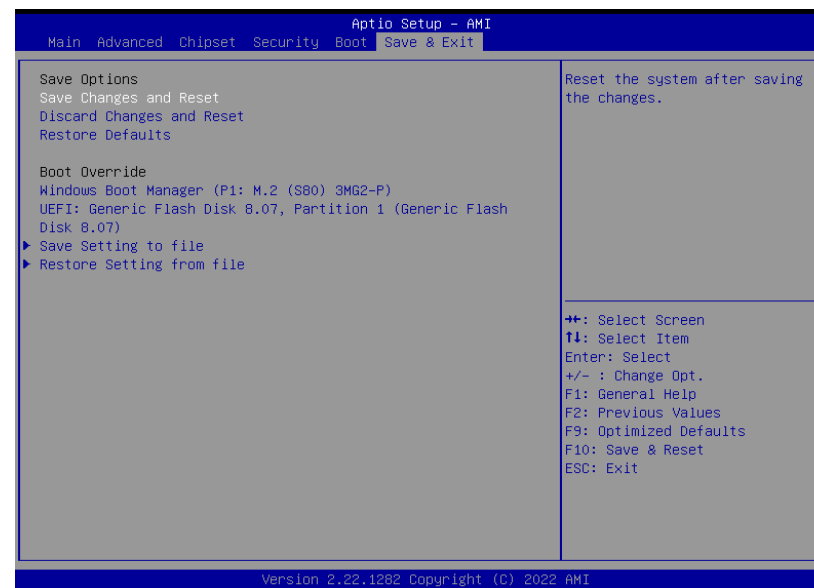

**Save Changes and Reset**

To save the changes, select this field and then press <Enter>. A dialog box will appear. Select Yes to reset the system after saving all changes made.

**Discard Changes and Reset**

To discard the changes, select this field and then press <Enter>. A dialog box will appear. Select Yes to reset the system setup without any changes.

**Restore Defaults**

To restore and load the optimized default values, select this field and then press <Enter>. A dialog box will appear. Select Yes to restore the default values of all the setup options.

**Boot Override**

Move the cursor to an available boot device and press Enter, and then the system will immediately boot from the selected boot device. The Boot Override function will only be effective for the current boot. The "Boot Option Priorities" configured in the Boot menu will not be changed.

- **Save Setting to file** Select this option to save BIOS configuration settings to a USB flash device.
- **Restore Setting from file** This field will appear only when a USB flash device is detected. Select this field to restore setting from the USB flash device.

## ► Updating the BIOS

To update the BIOS, you will need the new BIOS file and a flash utility. Please contact technical support or your sales representative for the files and specific instructions about how to update BIOS with the flash utility.

## ► Notice: BIOS SPI ROM

1. The Intel® Management Engine has already been integrated into this system board. Due to the safety concerns, the BIOS (SPI ROM) chip cannot be removed from this system board and used on another system board of the same model.
2. The BIOS (SPI ROM) on this system board must be the original equipment from the factory and cannot be used to replace one which has been utilized on other system boards.
3. If you do not follow the methods above, the Intel® Management Engine will not be updated and will cease to be effective.



**Note:**

- a. You can take advantage of flash tools to update the default configuration of the BIOS (SPI ROM) to the latest version anytime.
- b. When the BIOS IC needs to be replaced, you have to populate it properly onto the system board after the EEPROM programmer has been burned and follow the technical person's instructions to confirm that the MAC address should be burned or not.